

PILOT'S OPERATING HANDBOOK and FAA APPROVED AIRPLANE FLIGHT MANUAL

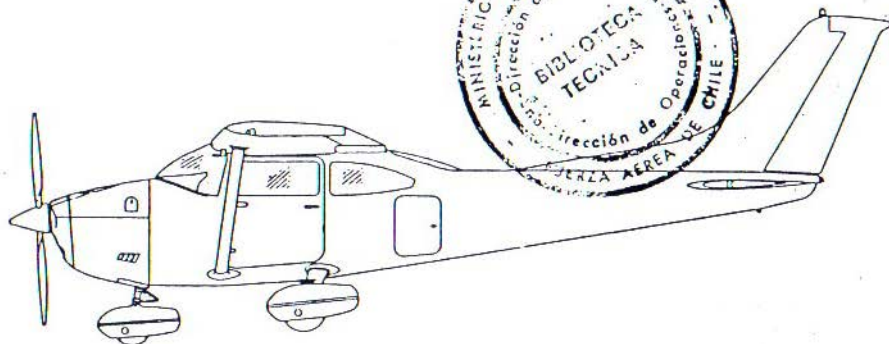

CESSNA AIRCRAFT COMPANY

1980 MODEL 182Q

KWJ

THIS DOCUMENT MUST BE
CARRIED IN THE AIRPLANE
AT ALL TIMES.

This manual is furnished to
~~Federal Aviation Authorities~~
as a part of the certification
Registration for this model.

THIS HANDBOOK INCLUDES THE MATERIAL REQUIRED TO BE
FURNISHED TO THE PILOT BY CAR PART 3 AND CONSTITUTES
THE FAA APPROVED AIRPLANE FLIGHT MANUAL.

COPYRIGHT © 1979

CESSNA AIRCRAFT COMPANY
WICHITA, KANSAS, USA



THIS MANUAL WAS PROVIDED FOR THE AIRPLANE
IDENTIFIED ON THE TITLE PAGE ON _____.
SUBSEQUENT REVISIONS SUPPLIED BY CESSNA
AIRCRAFT COMPANY MUST BE PROPERLY IN-
SERTED.

CESSNA AIRCRAFT COMPANY, PAWNEE DIVISION

REVISION

SKYLANE 1980 MODEL 182Q PILOT'S OPERATING HANDBOOK

REVISION 1

28 MARCH 1980

D1176R1-13PH

**INSERT THE FOLLOWING REVISED PAGES
INTO BASIC PILOT'S OPERATING HANDBOOK**

CONGRATULATIONS

Welcome to the ranks of Cessna owners! Your Cessna has been designed and constructed to give you the most in performance, economy, and comfort. It is our desire that you will find flying it, either for business or pleasure, a pleasant and profitable experience.

This Pilot's Operating Handbook has been prepared as a guide to help you get the most pleasure and utility from your airplane. It contains information about your Cessna's equipment, operating procedures, and performance; and suggestions for its servicing and care. We urge you to read it from cover to cover, and to refer to it frequently.

Our interest in your flying pleasure has not ceased with your purchase of a Cessna. World-wide, the Cessna Dealer Organization backed by the Cessna Customer Services Department stands ready to serve you. The following services are offered by most Cessna Dealers:

- THE CESSNA WARRANTY, which provides coverage for parts and labor, is available at Cessna Dealers worldwide. Specific benefits and provisions of warranty, plus other important benefits for you, are contained in your Customer Care Program book, supplied with your airplane. Warranty service is available to you at authorized Cessna Dealers throughout the world upon presentation of your Customer Care Card which establishes your eligibility under the warranty.
- FACTORY TRAINED PERSONNEL to provide you with courteous expert service.
- FACTORY APPROVED SERVICE EQUIPMENT to provide you efficient and accurate workmanship.
- A STOCK OF GENUINE CESSNA SERVICE PARTS on hand when you need them.
- THE LATEST AUTHORITATIVE INFORMATION FOR SERVICING CESSNA AIRPLANES, since Cessna Dealers have all of the Service Manuals and Parts Catalogs, kept current by Service Letters and Service News Letters, published by Cessna Aircraft Company.

We urge all Cessna owners to use the Cessna Dealer Organization to the fullest.

A current Cessna Dealer Directory accompanies your new airplane. The Directory is revised frequently, and a current copy can be obtained from your Cessna Dealer. Make your Directory one of your cross-country flight planning aids; a warm welcome awaits you at every Cessna Dealer.

PERFORMANCE - SPECIFICATIONS

SPEED:

Maximum at Sea Level 148 KNOTS

Cruise, 75% Power at 8000 Ft 144 KNOTS

CRUISE: Recommended lean mixture with fuel allowance for engine start, taxi, takeoff, climb and 45 minutes reserve.

75% Power at 8000 Ft Range 840 NM

88 Gallons Usable Fuel Time 5.9 HRS

Maximum Range at 10,000 Ft Range 1090 NM

88 Gallons Usable Fuel Time 9.7 HRS

RATE OF CLIMB AT SEA LEVEL 1010 FPM

SERVICE CEILING 16,500 FT

TAKEOFF PERFORMANCE:

Ground Roll 705 FT

Total Distance Over 50-Ft Obstacle 1350 FT

LANDING PERFORMANCE:

Ground Roll 590 FT

Total Distance Over 50-Ft Obstacle 1350 FT

STALL SPEED (CAS):

Flaps Up, Power Off 56 KNOTS

Flaps Down, Power Off 50 KNOTS

MAXIMUM WEIGHT:

Ramp 2960 LBS

Takeoff or Landing 2950 LBS

STANDARD EMPTY WEIGHT:

Skylane 1706 LBS

Skylane II 1762 LBS

MAXIMUM USEFUL LOAD:

Skylane 1254 LBS

Skylane II 1198 LBS

BAGGAGE ALLOWANCE 200 LBS

WING LOADING: Pounds/Sq Ft 16.9

POWER LOADING: Pounds/HP 12.8

FUEL CAPACITY: Total 92 GAL.

OIL CAPACITY 12 QTS

ENGINE: Teledyne Continental O-470-U

230 BHP at 2400 RPM

PROPELLER: Constant Speed, Diameter 82 IN.

COVERAGE

The Pilot's Operating Handbook in the airplane at the time of delivery from Cessna Aircraft Company contains information applicable to the 1980 Model 182Q airplane designated by the serial number and registration number shown on the Title Page of this handbook.

REVISIONS

Changes and/or additions to this handbook will be covered by revisions published by Cessna Aircraft Company. These revisions are distributed to all Cessna Dealers and to owners of U. S. Registered aircraft according to FAA records at the time of revision issuance.

Revisions should be examined immediately upon receipt and incorporated in this handbook.

NOTE

It is the responsibility of the owner to maintain this handbook in a current status when it is being used for operational purposes.

Owners should contact their Cessna Dealer whenever the revision status of their handbook is in question.

A revision bar will extend the full length of new or revised text and/or illustrations added on new or presently existing pages. This bar will be located adjacent to the applicable revised area on the outer margin of the page.

All revised pages will carry the revision number and date on the applicable page.

The following Log of Effective Pages provides the dates of issue for original and revised pages, and a listing of all pages in the handbook. Pages affected by the current revision are indicated by an asterisk (*) preceding the pages listed.

LOG OF EFFECTIVE PAGES

Dates of issue for original and revised pages are:

Original 1 October 1979
Revision 1 28 March 1980

Page	Date	Page	Date
Title	1 October 1979	5-3 thru 5-29	1 October 1979
Assignment Record ...	1 October 1979	5-30 Blank	1 October 1979
i thru ii	1 October 1979	6-1	1 October 1979
*iii	28 March 1980	6-2 Blank	1 October 1979
iv	1 October 1979	6-3 thru 6-13	1 October 1979
1-1 thru 1-8	1 October 1979	6-14 Blank	1 October 1979
2-1	1 October 1979	6-15 thru 6-25	1 October 1979
2-2 Blank	1 October 1979	6-26 Blank	1 October 1979
2-3 thru 2-10	1 October 1979	7-1 thru 7-43	1 October 1979
*2-11	28 March 1980	7-44 Blank	1 October 1979
2-12 Blank	1 October 1979	8-1	1 October 1979
3-1 thru 3-9	1 October 1979	8-2 Blank	1 October 1979
3-10 Blank	1 October 1979	8-3 thru 8-17	1 October 1979
3-11 thru 3-18	1 October 1979	8-18 Blank	1 October 1979
4-1 thru 4-11	1 October 1979	9-1 thru 9-3	1 October 1979
4-12 Blank	1 October 1979	9-4 Blank	1 October 1979
4-13 thru 4-23	1 October 1979		
4-24 Blank	1 October 1979		
5-1	1 October 1979		
5-2 Blank	1 October 1979		

NOTE

Refer to Section 9 Table of Contents for supplements applicable to optional systems.

1 October 1979

Revision 1 - 28 March 1980

D1176-1-13PH — CES — 1050 — 4/80

TABLE OF CONTENTS

	SECTION
GENERAL.....	1
LIMITATIONS.....	2
EMERGENCY PROCEDURES.....	3
NORMAL PROCEDURES.....	4
PERFORMANCE.....	5
WEIGHT & BALANCE/ EQUIPMENT LIST	6
AIRPLANE & SYSTEMS DESCRIPTIONS	7
AIRPLANE HANDLING, SERVICE & MAINTENANCE	8
SUPPLEMENTS (Optional Systems Description & Operating Procedures)	9

SECTION 1 GENERAL



TABLE OF CONTENTS

	Page
Three View	1-2
Introduction	1-3
Descriptive Data	1-3
Engine	1-3
Propeller	1-3
Fuel	1-3
Oil	1-4
Maximum Certificated Weights	1-4
Standard Airplane Weights	1-5
Cabin And Entry Dimensions	1-5
Baggage Space and Entry Dimensions	1-5
Specific Loadings	1-5
Symbols, Abbreviations And Terminology	1-5
General Airspeed Terminology And Symbols	1-5
Meteorological Terminology	1-6
Engine Power Terminology	1-7
Airplane Performance And Flight Planning Terminology	1-7
Weight And Balance Terminology	1-7

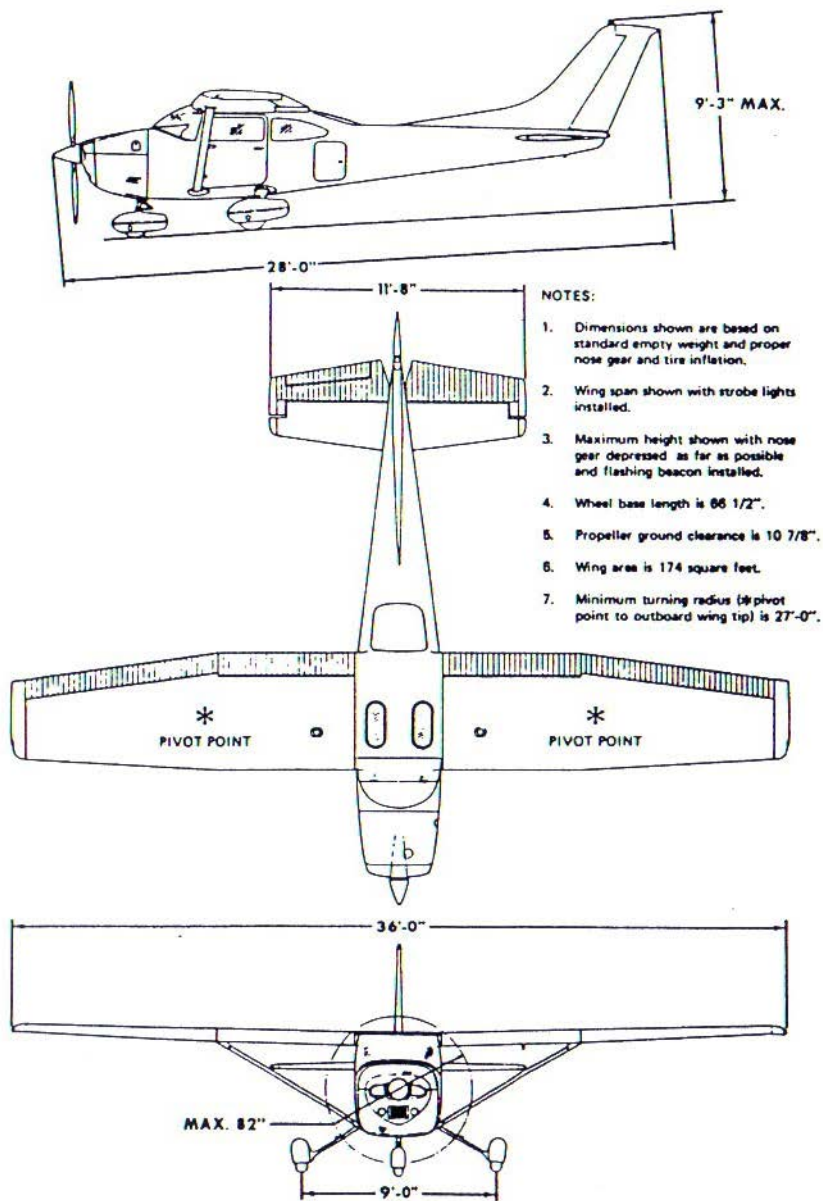

Figure 1-1. Three View

INTRODUCTION

This handbook contains 9 sections, and includes the material required to be furnished to the pilot by CAR Part 3. It also contains supplemental data supplied by Cessna Aircraft Company.

Section 1 provides basic data and information of general interest. It also contains definitions or explanations of symbols, abbreviations, and terminology commonly used.

DESCRIPTIVE DATA

ENGINE

Number of Engines: 1.

Engine Manufacturer: Teledyne Continental.

Engine Model Number: O-470-U.

Engine Type: Normally-aspirated, direct-drive, air-cooled, horizontally-opposed, carburetor-equipped, six-cylinder engine with 470 cu. in. displacement.

Horsepower Rating and Engine Speed: 230 rated BHP at 2400 RPM.

PROPELLER

Propeller Manufacturer: McCauley Accessory Division.

Propeller Model Number: C2A34C204/90DCB-8.

Number of Blades: 2.

Propeller Diameter, Maximum: 82 inches.

Minimum: 80.5 inches.

Propeller Type: Constant speed and hydraulically actuated, with a low pitch setting of 15.0° and a high pitch setting of 29.4° (30 inch station).

FUEL

Approved Fuel Grades (and Colors):

100LL Grade Aviation Fuel (Blue).

100 (Formerly 100/130) Grade Aviation Fuel (Green).

NOTE

Isopropyl alcohol or ethylene glycol monomethyl ether may be added to the fuel supply. Additive concentrations shall not exceed 1% for isopropyl alcohol or .15% for ethylene glycol monomethyl ether. Refer to Section 8 for additional information.

Total Capacity: 92 gallons.
Total Capacity Each Tank: 46 gallons.
Total Usable: 88 gallons.

NOTE

To ensure maximum fuel capacity when refueling and minimize cross-feeding when parked on a sloping surface, place the fuel selector valve in either LEFT or RIGHT position to minimize cross-feeding.

OIL

Oil Grade (Specification):

MIL-L-6082 Aviation Grade Straight Mineral Oil: Use to replenish supply during first 25 hours and at the first 25-hour oil change. Continue to use until a total of 50 hours has accumulated or oil consumption has stabilized.

NOTE

The airplane was delivered from the factory with a corrosion preventive aircraft engine oil. This oil should be drained after the first 25 hours of operation.

Continental Motors Specification MHS-24 (and all revisions thereto), Ashless Dispersant Oil: This oil must be used after first 50 hours or oil consumption has stabilized.

Recommended Viscosity for Temperature Range:

All temperatures, use SAE 20W-50 or
Above 4°C (40°F), use SAE 50.
Below 4°C (40°F), use SAE 30.

NOTE

Multi-viscosity oil with a range of SAE 20W-50 is recommended for improved starting in cold weather.

Oil Capacity:

Sump: 12 Quarts.
Total: 13 Quarts (if oil filter installed).

MAXIMUM CERTIFICATED WEIGHTS

Ramp: 2960 lbs.
Takeoff: 2950 lbs.
Landing: 2950 lbs.

Weight in Baggage Compartment:

Baggage Area "A" (or passenger on child's seat) - Station 82 to 108: 120 lbs. See note below.

Baggage Area "B" and Hatshelf-Station 108 to 136: 80 lbs. See note below.

NOTE

The maximum combined weight capacity for baggage areas A and B, including the hatshelf, is 200 lbs. The maximum hatshelf load is 25 lbs.

STANDARD AIRPLANE WEIGHTS

Standard Empty Weight, Skylane: 1706 lbs.
Skylane II: 1762 lbs.

Maximum Useful Load, Skylane: 1254 lbs.
Skylane II: 1198 lbs.

CABIN AND ENTRY DIMENSIONS

Detailed dimensions of the cabin interior and entry door openings are illustrated in Section 6.

BAGGAGE SPACE AND ENTRY DIMENSIONS

Dimensions of the baggage area and baggage door opening are illustrated in detail in Section 6.

SPECIFIC LOADINGS

Wing Loading: 16.9 lbs./sq. ft.
Power Loading: 12.8 lbs./hp.

SYMBOLS, ABBREVIATIONS AND TERMINOLOGY

GENERAL AIRSPEED TERMINOLOGY AND SYMBOLS

KCAS **Knots Calibrated Airspeed** is indicated airspeed corrected for position and instrument error and expressed in knots. Knots calibrated airspeed is equal to KTAS in standard atmosphere at sea level.

KIAS **Knots Indicated Airspeed** is the speed shown on the airspeed indicator and expressed in knots.

- KTAS** **Knots True Airspeed** is the airspeed expressed in knots relative to undisturbed air which is KCAS corrected for altitude and temperature.
- V_A** **Maneuvering Speed** is the maximum speed at which you may use abrupt control travel.
- V_{FE}** **Maximum Flap Extended Speed** is the highest speed permissible with wing flaps in a prescribed extended position.
- V_{NO}** **Maximum Structural Cruising Speed** is the speed that should not be exceeded except in smooth air, then only with caution.
- V_{NE}** **Never Exceed Speed** is the speed limit that may not be exceeded at any time.
- V_S** **Stalling Speed** or the minimum steady flight speed at which the airplane is controllable.
- V_{SO}** **Stalling Speed** or the minimum steady flight speed at which the airplane is controllable in the landing configuration at the most forward center of gravity.
- V_X** **Best Angle-of-Climb Speed** is the speed which results in the greatest gain of altitude in a given horizontal distance.
- V_Y** **Best Rate-of-Climb Speed** is the speed which results in the greatest gain in altitude in a given time.

METEOROLOGICAL TERMINOLOGY

- OAT** **Outside Air Temperature** is the free air static temperature. It is expressed in either degrees Celsius or degrees Fahrenheit.
- Standard Temperature** **Standard Temperature** is 15°C at sea level pressure altitude and decreases by 2°C for each 1000 feet of altitude.
- Pressure Altitude** **Pressure Altitude** is the altitude read from an altimeter when the altimeter's barometric scale has been set to 29.92 inches of mercury (1013 mb).

ENGINE POWER TERMINOLOGY

BHP	Brake Horsepower is the power developed by the engine.
RPM	Revolutions Per Minute is engine speed.
MP	Manifold Pressure is a pressure measured in the engine's induction system and is expressed in inches of mercury (Hg).

AIRPLANE PERFORMANCE AND FLIGHT PLANNING TERMINOLOGY

Demonstrated Crosswind Velocity	Demonstrated Crosswind Velocity is the velocity of the crosswind component for which adequate control of the airplane during takeoff and landing was actually demonstrated during certification tests. The value shown is not considered to be limiting.
Usable Fuel	Usable Fuel is the fuel available for flight planning.
Unusable Fuel	Unusable Fuel is the quantity of fuel that can not be safely used in flight.
GPH	Gallons Per Hour is the amount of fuel (in gallons) consumed per hour.
NMPG	Nautical Miles Per Gallon is the distance (in nautical miles) which can be expected per gallon of fuel consumed at a specific engine power setting and/or flight configuration.
g	g is acceleration due to gravity.

WEIGHT AND BALANCE TERMINOLOGY

Reference Datum	Reference Datum is an imaginary vertical plane from which all horizontal distances are measured for balance purposes.
Station	Station is a location along the airplane fuselage given in terms of the distance from the reference datum.
Arm	Arm is the horizontal distance from the reference datum to the center of gravity (C.G.) of an item.
Moment	Moment is the product of the weight of an item multiplied

by its arm. (Moment divided by the constant 1000 is used in this handbook to simplify balance calculations by reducing the number of digits.)

Center of Gravity (C.G.)	Center of Gravity is the point at which an airplane, or equipment, would balance if suspended. Its distance from the reference datum is found by dividing the total moment by the total weight of the airplane.
C.G. Arm	Center of Gravity Arm is the arm obtained by adding the airplane's individual moments and dividing the sum by the total weight.
C.G. Limits	Center of Gravity Limits are the extreme center of gravity locations within which the airplane must be operated at a given weight.
Standard Empty Weight	Standard Empty Weight is the weight of a standard airplane, including unusable fuel, full operating fluids and full engine oil.
Basic Empty Weight	Basic Empty Weight is the standard empty weight plus the weight of optional equipment.
Useful Load	Useful Load is the difference between ramp weight and the basic empty weight.
Maximum Ramp Weight	Maximum Ramp Weight is the maximum weight approved for ground maneuver. (It includes the weight of start, taxi and runup fuel.)
Maximum Takeoff Weight	Maximum Takeoff Weight is the maximum weight approved for the start of the takeoff run.
Maximum Landing Weight	Maximum Landing Weight is the maximum weight approved for the landing touchdown.
Tare	Tare is the weight of chocks, blocks, stands, etc. used when weighing an airplane, and is included in the scale readings. Tare is deducted from the scale reading to obtain the actual (net) airplane weight.

SECTION 2 LIMITATIONS



TABLE OF CONTENTS

	Page
Introduction	2-3
Airspeed Limitations	2-4
Airspeed Indicator Markings	2-4
Power Plant Limitations	2-5
Power Plant Instrument Markings	2-6
Weight Limits	2-6
Center Of Gravity Limits	2-7
Maneuver Limits	2-7
Flight Load Factor Limits	2-7
Kinds Of Operation Limits	2-7
Fuel Limitations	2-8
Other Limitations	2-8
Flap Limitations	2-8
Placards	2-9

INTRODUCTION

Section 2 includes operating limitations, instrument markings, and basic placards necessary for the safe operation of the airplane, its engine, standard systems and standard equipment. The limitations included in this section and in Section 9 have been approved by the Federal Aviation Administration. Observance of these operating limitations is required by Federal Aviation Regulations.

NOTE

Refer to Section 9 of this Pilot's Operating Handbook for amended operating limitations, operating procedures, performance data and other necessary information for airplanes equipped with specific options.

NOTE

The airspeeds listed in the Airspeed Limitations chart (figure 2-1) and the Airspeed Indicator Markings chart (figure 2-2) are based on Airspeed Calibration data shown in Section 5 with the normal static source. If the alternate static source is being used, ample margins should be observed to allow for the airspeed calibration variations between the normal and alternate static sources as shown in Section 5.

Your Cessna is certificated under FAA Type Certificate No. 3A13 as Cessna Model No. 182Q.

AIRSPPEED LIMITATIONS

Airspeed limitations and their operational significance are shown in figure 2-1.

	SPEED	KCAS	KIAS	REMARKS
V _{NE}	Never Exceed Speed	172	179	Do not exceed this speed in any operation.
V _{NO}	Maximum Structural Cruising Speed	139	143	Do not exceed this speed except in smooth air, and then only with caution.
V _A	Maneuvering Speed: 2950 Pounds 2450 Pounds 1950 Pounds	109 99 89	111 100 89	Do not make full or abrupt control movements above this speed.
V _{FE}	Maximum Flap Extended Speed: To 10° Flaps 10° - 40° Flaps	137 95	140 95	Do not exceed these speeds with the given flap settings.
	Maximum Window Open Speed	172	179	Do not exceed this speed with windows open.

Figure 2-1. Airspeed Limitations

AIRSPPEED INDICATOR MARKINGS

Airspeed indicator markings and their color code significance are shown in figure 2-2.

MARKING	KIAS VALUE OR RANGE	SIGNIFICANCE
White Arc	45 - 95	Full Flap Operating Range. Lower limit is maximum weight V_{SO} in landing configuration. Upper limit is maximum speed permissible with flaps extended.
Green Arc	48 - 143	Normal Operating Range. Lower limit is maximum weight V_S at most forward C.G. with flaps retracted. Upper limit is maximum structural cruising speed.
Yellow Arc	143 - 179	Operations must be conducted with caution and only in smooth air.
Red Line	179	Maximum speed for all operations.

Figure 2-2. Airspeed Indicator Markings

POWER PLANT LIMITATIONS

Engine Manufacturer: Teledyne Continental.

Engine Model Number: O-470-U.

Engine Operating Limits for Takeoff and Continuous Operations:

Maximum Power: 230 BHP rating.

Maximum Engine Speed: 2400 RPM.

Maximum Cylinder Head Temperature: 460°F (238°C).

Maximum Oil Temperature: 240°F (116°C).

Oil Pressure, Minimum: 10 psi.

Maximum: 100 psi.

Propeller Manufacturer: McCauley Accessory Division.

Propeller Model Number: C2A34C204/90DCB-8

Propeller Diameter, Maximum: 82 inches.

Minimum: 80.5 inches.

Propeller Blade Angle at 30 Inch Station, Low: 15.0°.

High: 29.4°.

POWER PLANT INSTRUMENT MARKINGS

Power plant instrument markings and their color code significance are shown in figure 2-3.

INSTRUMENT	RED LINE	GREEN ARC	RED LINE
	MINIMUM LIMIT	NORMAL OPERATING	MAXIMUM LIMIT
Tachometer	---	2100 - 2400 RPM	2400 RPM
Manifold Pressure	---	15-23 in. Hg	---
Oil Temperature	---	100° - 240°F	240°F
Cylinder Head Temperature	---	200° - 460°F	460°F
Oil Pressure	10 psi	30-60 psi	100 psi
Suction	---	4.5-5.4 in. Hg	---
Fuel Quantity	E (2.0 Gal. Unusable Each Tank)	---	---

Figure 2-3. Power Plant Instrument Markings

WEIGHT LIMITS

Maximum Ramp Weight: 2960 lbs.

Maximum Takeoff Weight: 2950 lbs.

Maximum Landing Weight: 2950 lbs.

Maximum Weight in Baggage Compartment:

Baggage Area "A" (or passenger on child's seat) - Station 82 to 108: 120 lbs. See note below.

Baggage Area "B" and Hatshelf- Station 108 to 136: 80 lbs. See note below.

NOTE

The maximum combined weight capacity for baggage areas A and B, including the hatshelf, is 200 lbs. The maximum hatshelf load is 25 lbs.

CENTER OF GRAVITY LIMITS

Center of Gravity Range:

Forward: 33.0 inches aft of datum at 2250 lbs. or less, with straight line variation to 39.5 inches aft of datum at 2950 lbs.

Aft: 48.5 inches aft of datum at all weights.

Reference Datum: Front face of firewall.

MANEUVER LIMITS

This airplane is certificated in the normal category. The normal category is applicable to aircraft intended for non-aerobatic operations. These include any maneuvers incidental to normal flying, stalls (except whip stalls), lazy eights, chandelles, and steep turns in which the angle of bank is not more than 60°.

Aerobatic maneuvers, including spins, are not approved.

FLIGHT LOAD FACTOR LIMITS

Flight Load Factors:

*Flaps Up: +3.8g, -1.52g

*Flaps Down: +2.0g

*The design load factors are 150% of the above, and in all cases, the structure meets or exceeds design loads.

KINDS OF OPERATION LIMITS

The airplane is equipped for day VFR and may be equipped for night VFR and/or IFR operations. FAR Part 91 establishes the minimum required instrumentation and equipment for these operations. The reference to types of flight operations on the operating limitations placard reflects equipment installed at the time of Airworthiness Certificate issuance.

Flight into known icing conditions is prohibited.

FUEL LIMITATIONS

- 2 Standard Tanks: 46 U.S. gallons each.
- Total Fuel: 92 U.S. gallons.
- Usable Fuel (all flight conditions): 88 U.S. gallons.
- Unusable Fuel: 4 U.S. gallons.

NOTE

To ensure maximum fuel capacity when refueling and minimize cross-feeding when parked on a sloping surface, place the fuel selector valve in either LEFT or RIGHT position.

Takeoff and land with the fuel selector valve handle in BOTH position.

Operation on either left or right tank limited to level flight only.

With 1/4 tank or less, prolonged uncoordinated flight is prohibited when operating on either left or right tank in level flight.

Approved Fuel Grades (and Colors):

100LL Grade Aviation Fuel (Blue).

100 (Formerly 100/130) Grade Aviation Fuel (Green).

OTHER LIMITATIONS

FLAP LIMITATIONS

Approved Takeoff Range: 0° to 20°.

Approved Landing Range: 0° to 40°.

PLACARDS

The following information must be displayed in the form of composite or individual placards.

1. In full view of the pilot: (The "DAY-NIGHT-VFR-IFR" entry, shown on the example below, will vary as the airplane is equipped.)

The markings and placards installed in this airplane contain operating limitations which must be complied with when operating this airplane in the Normal Category. Other operating limitations which must be complied with when operating this airplane in this category are contained in the Pilot's Operating Handbook and FAA Approved Airplane Flight Manual.

No acrobatic maneuvers, including spins, approved.

Flight into known icing conditions prohibited.

This airplane is certified for the following flight operations as of date of original airworthiness certificate:

DAY-NIGHT-VFR-IFR

2. On control lock:

CONTROL LOCK- REMOVE BEFORE STARTING ENGINE

3. On the fuel selector valve plate:

OFF
LEFT - 44 GAL. LEVEL FLIGHT ONLY
BOTH - 88 GAL. ALL FLIGHT ATTITUDES
BOTH ON FOR TAKEOFF AND LANDING
RIGHT - 44 GAL. LEVEL FLIGHT ONLY

4. On the baggage door:

FORWARD OF BAGGAGE DOOR LATCH
120 POUNDS MAXIMUM
BAGGAGE AND/OR AUXILIARY PASSENGER

AFT OF BAGGAGE DOOR LATCH
80 POUNDS MAXIMUM
BAGGAGE INCLUDING 25 LBS MAXIMUM IN
BAGGAGE WALL HATSHELF

MAXIMUM 200 POUNDS COMBINED
FOR ADDITIONAL LOADING INSTRUCTIONS SEE
WEIGHT AND BALANCE DATA

5. On flap control indicator:

0° to 10°

(Partial flap range with blue
code and 140 kt callout; also,
mechanical detent at 10°.)

10° to 20° to FULL

(Indices at these positions with white
color code and 95 kt callout; also,
mechanical detent at 10° and 20°.)

6. Forward of fuel tank filler cap:

FUEL

100LL/100 MIN. GRADE AVIATION GASOLINE
CAP. 46.0 U.S. GAL.
CAP. 34.5 U.S. GAL. TO BOTTOM OF FILLER NECK

7. A calibration card is provided to indicate the accuracy of the magnetic compass in 30° increments.

8. On oil filler cap:

OIL
12 QTS

9. Near airspeed indicator:

MANEUVER SPEED
111 KIAS

10. Forward of each fuel tank filler cap in line with fwd arrow.

FUEL CAP FWD ↓ ARROW ALIGNMENT
CAP MUST NOT ROTATE DURING CLOSING

SECTION 3 EMERGENCY PROCEDURES



TABLE OF CONTENTS

	Page
Introduction	3-3
Airspeeds For Emergency Operation	3-3

OPERATIONAL CHECKLISTS

Engine Failures	3-3
Engine Failure During Takeoff Run	3-3
Engine Failure Immediately After Takeoff	3-4
Engine Failure During Flight	3-4
Forced Landings	3-4
Emergency Landing Without Engine Power	3-4
Precautionary Landing With Engine Power	3-4
Ditching	3-5
Fires	3-5
During Start On Ground	3-5
Engine Fire In Flight	3-6
Electrical Fire In Flight	3-6
Cabin Fire	3-7
Wing Fire	3-7
Icing	3-7
Inadvertent Icing Encounter	3-7
Static Source Blockage (Erroneous Instrument Reading Suspected)	3-8
Landing With A Flat Main Tire	3-8
Electrical Power Supply System Malfunctions	3-8
Ammeter Shows Excessive Rate of Charge (Full Scale Deflection)	3-8
Low-Voltage Light Illuminates During Flight (Ammeter Indicates Discharge)	3-8

AMPLIFIED PROCEDURES

Engine Failure	3-11
Forced Landings	3-12

TABLE OF CONTENTS (Continued)

	Page
Landing Without Elevator Control	3-12
Fires	3-12
Emergency Operation In Clouds (Vacuum System Failure)	3-13
Executing A 180° Turn In Clouds	3-13
Emergency Descent Through Clouds	3-13
Recovery From A Spiral Dive	3-14
Inadvertent Flight Into Icing Conditions	3-14
Static Source Blocked	3-14
Spins	3-15
Rough Engine Operation Or Loss Of Power	3-15
Carburetor Icing	3-15
Spark Plug Fouling	3-16
Magneto Malfunction	3-16
Low Oil Pressure	3-16
Electrical Power Supply System Malfunctions	3-17
Excessive Rate Of Charge	3-17
Insufficient Rate Of Charge	3-17

INTRODUCTION

Section 3 provides checklist and amplified procedures for coping with emergencies that may occur. Emergencies caused by airplane or engine malfunctions are extremely rare if proper preflight inspections and maintenance are practiced. Enroute weather emergencies can be minimized or eliminated by careful flight planning and good judgment when unexpected weather is encountered. However, should an emergency arise, the basic guidelines described in this section should be considered and applied as necessary to correct the problem. Emergency procedures associated with ELT and other optional systems can be found in Section 9.

AIRSPEEDS FOR EMERGENCY OPERATION

Engine Failure After Takeoff:	
Wing Flaps Up	70 KIAS
Wing Flaps Down	65 KIAS
Maneuvering Speed:	
2950 Lbs	111 KIAS
2450 Lbs	100 KIAS
1950 Lbs	89 KIAS
Maximum Glide	70 KIAS
Precautionary Landing With Engine Power	65 KIAS
Landing Without Engine Power:	
Wing Flaps Up	70 KIAS
Wing Flaps Down	65 KIAS

OPERATIONAL CHECKLISTS

ENGINE FAILURES

ENGINE FAILURE DURING TAKEOFF RUN

1. Throttle -- IDLE.
2. Brakes -- APPLY.
3. Wing Flaps -- RETRACT.
4. Mixture -- IDLE CUT-OFF.
5. Ignition Switch -- OFF.
6. Master Switch -- OFF.

ENGINE FAILURE IMMEDIATELY AFTER TAKEOFF

1. Airspeed -- 70 KIAS (flaps UP).
65 KIAS (flaps DOWN).
2. Mixture -- IDLE CUT-OFF.
3. Fuel Selector Valve -- OFF.
4. Ignition Switch -- OFF.
5. Wing Flaps -- AS REQUIRED (40° recommended).
6. Master Switch -- OFF.

ENGINE FAILURE DURING FLIGHT

1. Airspeed -- 70 KIAS.
2. Carburetor Heat -- ON.
3. Fuel Selector Valve -- BOTH
4. Mixture -- RICH.
5. Ignition Switch -- BOTH (or START if propeller is stopped).
6. Primer -- IN and LOCKED.

FORCED LANDINGS

EMERGENCY LANDING WITHOUT ENGINE POWER

1. Airspeed -- 70 KIAS (flaps UP).
65 KIAS (flaps DOWN).
2. Mixture -- IDLE CUT-OFF.
3. Fuel Selector Valve -- OFF.
4. Ignition Switch -- OFF.
5. Wing Flaps -- AS REQUIRED (40° recommended).
6. Master Switch -- OFF.
7. Doors -- UNLATCH PRIOR TO TOUCHDOWN.
8. Touchdown -- SLIGHTLY TAIL LOW.
9. Brakes -- APPLY HEAVILY.

PRECAUTIONARY LANDING WITH ENGINE POWER

1. Airspeed -- 65 KIAS.
2. Wing Flaps -- 20°.
3. Selected Field -- FLY OVER, noting terrain and obstructions, then retract flaps upon reaching a safe altitude and airspeed.
4. Electrical Switches -- OFF.
5. Wing Flaps -- 40° (on final approach).
6. Airspeed -- 65 KIAS.
7. Avionics Power and Master Switches -- OFF.
8. Doors -- UNLATCH PRIOR TO TOUCHDOWN.

9. Touchdown -- SLIGHTLY TAIL LOW.
10. Ignition Switch -- OFF.
11. Brakes -- APPLY HEAVILY.

DITCHING

1. Radio -- TRANSMIT MAYDAY on 121.5 MHz, giving location and intentions and SQUAWK 7700 if transponder is installed.
2. Heavy Objects (in baggage area) -- SECURE OR JETTISON.
3. Flaps -- 20° - 40°.
4. Power -- ESTABLISH 300 FT/MIN DESCENT at 60 KIAS.
5. Approach -- High Winds, Heavy Seas -- INTO THE WIND.
Light Winds, Heavy Swells -- PARALLEL TO SWELLS.

NOTE

If no power is available, approach at 70 KIAS with flaps up or at 65 KIAS with 10° flaps.

6. Cabin Doors -- UNLATCH.
7. Touchdown -- LEVEL ATTITUDE AT ESTABLISHED DESCENT.
8. Face -- CUSHION at touchdown with folded coat.
9. Airplane -- EVACUATE through cabin doors. If necessary, open window and flood cabin to equalize pressure so doors can be opened.
10. Life Vests and Raft -- INFLATE.

FIRES

DURING START ON GROUND

1. Cranking -- CONTINUE, to get a start which would suck the flames and accumulated fuel through the carburetor and into the engine.

If engine starts:

2. Power -- 1700 RPM for a few minutes.
3. Engine -- SHUTDOWN and inspect for damage.

If engine fails to start:

4. Throttle -- FULL OPEN.
5. Mixture -- IDLE CUT-OFF.
6. Cranking -- CONTINUE.

7. Fire Extinguisher -- OBTAIN (have ground attendants obtain if not installed).
8. Engine -- SECURE.
 - a. Master Switch -- OFF.
 - b. Ignition Switch -- OFF.
 - c. Fuel Selector Valve -- OFF.
9. Fire -- EXTINGUISH using fire extinguisher, wool blanket, or dirt.
10. Fire Damage -- INSPECT, repair damage or replace damaged components or wiring before conducting another flight.

ENGINE FIRE IN FLIGHT

1. Mixture -- IDLE CUT-OFF.
2. Fuel Selector Valve -- OFF.
3. Master Switch -- OFF.
4. Cabin Heat and Air -- OFF (except overhead vents).
5. Airspeed -- 100 KIAS (If fire is not extinguished, increase glide speed to find an airspeed which will provide an incombustible mixture).
6. Forced Landing -- EXECUTE (as described in Emergency Landing Without Engine Power).

ELECTRICAL FIRE IN FLIGHT

1. Master Switch -- OFF.
2. Avionics Power Switch -- OFF.
3. All Other Switches (except ignition switch) -- OFF.
4. Vents/Cabin Air/Heat -- CLOSED.
5. Fire Extinguisher -- ACTIVATE (if available).

WARNING

After discharging an extinguisher within a closed cabin, ventilate the cabin.

If fire appears out and electrical power is necessary for continuance of flight:

6. Master Switch -- ON.
7. Circuit Breakers -- CHECK for faulty circuit, do not reset.
8. Radio Switches -- OFF.
9. Avionics Power Switch -- ON.
10. Radio/Electrical Switches -- ON one at a time, with delay after each until short circuit is localized.
11. Vents/Cabin Air/Heat -- OPEN when it is ascertained that fire is completely extinguished.

CABIN FIRE

1. Master Switch -- OFF.
2. Vents/Cabin Air/Heat -- CLOSED (to avoid drafts).
3. Fire Extinguisher -- ACTIVATE (if available).

WARNING

After discharging an extinguisher within a closed cabin, ventilate the cabin.

4. Land the airplane as soon as possible to inspect for damage.

WING FIRE

1. Navigation Light Switch -- OFF.
2. Strobe Light Switch (if installed) -- OFF.
3. Pitot Heat Switch (if installed) -- OFF.

NOTE

Perform a sideslip to keep the flames away from the fuel tank and cabin, and land as soon as possible using flaps only as required for final approach and touchdown.

ICING

INADVERTENT ICING ENCOUNTER

1. Turn pitot heat switch ON (if installed).
2. Turn back or change altitude to obtain an outside air temperature that is less conducive to icing.
3. Pull cabin heat control full out and rotate defroster control clockwise to obtain maximum defroster airflow.
4. Increase engine speed to minimize ice build-up on propeller blades.
5. Watch for signs of carburetor air filter ice and apply carburetor heat as required. An unexplained loss in manifold pressure could be caused by carburetor ice or air intake filter ice. Lean the mixture if carburetor heat is used continuously.
6. Plan a landing at the nearest airport. With an extremely rapid ice build-up, select a suitable "off airport" landing site.
7. With an ice accumulation of 1/4 inch or more on the wing leading edges, be prepared for significantly higher stall speed.
8. Leave wing flaps retracted. With a severe ice build-up on the horizontal tail, the change in wing wake airflow direction caused

by wing flap extension could result in a loss of elevator effectiveness.

9. Open left window and if practical scrape ice from a portion of the windshield for visibility in the landing approach.
10. Perform a landing approach using a forward slip, if necessary, for improved visibility.
11. Approach at 80 to 90 KIAS depending upon the amount of ice accumulation.
12. Perform a landing in level attitude.

STATIC SOURCE BLOCKAGE (Erroneous Instrument Reading Suspected)

1. Alternate Static Source Valve (if installed) -- PULL ON.
2. Airspeed -- Consult appropriate table in Section 5.
3. Altitude -- Cruise 50 feet higher and approach 30 feet higher than normal.

LANDING WITH A FLAT MAIN TIRE

1. Approach -- NORMAL.
2. Wing Flaps -- FULL DOWN.
3. Touchdown -- GOOD TIRE FIRST, hold airplane off flat tire as long as possible with aileron control.

ELECTRICAL POWER SUPPLY SYSTEM MALFUNCTIONS

AMMETER SHOWS EXCESSIVE RATE OF CHARGE (Full Scale Deflection)

1. Alternator -- OFF.
2. Alternator Circuit Breaker -- PULL.
3. Nonessential Electrical Equipment -- OFF.
4. Flight -- TERMINATE as soon as practical.

LOW-VOLTAGE LIGHT ILLUMINATES DURING FLIGHT (Ammeter Indicates Discharge)

NOTE

Illumination of the low-voltage light may occur during low RPM conditions with an electrical load on the system

such as during a low RPM taxi. Under these conditions, the light will go out at higher RPM. The master switch need not be recycled since an over-voltage condition has not occurred to de-activate the alternator system.

1. Avionics Power Switch -- OFF.
2. Alternator Circuit Breaker -- CHECK IN.
3. Master Switch -- OFF (both sides).
4. Master Switch -- ON.
5. Low-Voltage Light -- CHECK OFF.
6. Avionics Power Switch -- ON.

If low-voltage light illuminates again:

7. Alternator -- OFF.
8. Nonessential Radio and Electrical Equipment -- OFF.
9. Flight -- TERMINATE as soon as practical.

AMPLIFIED PROCEDURES

ENGINE FAILURE

If an engine failure occurs during the takeoff run, the most important thing to do is stop the airplane on the remaining runway. Those extra items on the checklist will provide added safety after a failure of this type.

Prompt lowering of the nose to maintain airspeed and establish a glide attitude is the first response to an engine failure after takeoff. In most cases, the landing should be planned straight ahead with only small changes in direction to avoid obstructions. Altitude and airspeed are seldom sufficient to execute a 180° gliding turn necessary to return to the runway. The checklist procedures assume that adequate time exists to secure the fuel and ignition systems prior to touchdown.

After an engine failure in flight, the best glide speed as shown in figure 3-1 should be established as quickly as possible. While gliding toward a suitable landing area, an effort should be made to identify the cause of the failure. If time permits, an engine restart should be attempted as shown in the checklist. If the engine cannot be restarted, a forced landing without power must be completed.

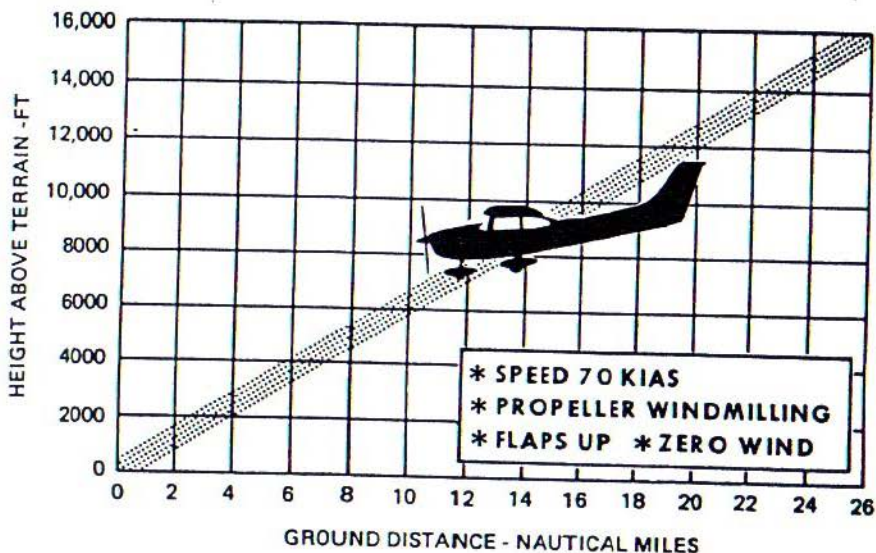

Figure 3-1. Maximum Glide

FORCED LANDINGS

If all attempts to restart the engine fail and a forced landing is imminent, select a suitable field and prepare for the landing as discussed in the checklist for Emergency Landing Without Engine Power.

Before attempting an "off airport" landing with engine power available, one should fly over the landing area at a safe but low altitude to inspect the terrain for obstructions and surface conditions, proceeding as discussed under the Precautionary Landing With Engine Power checklist.

Prepare for ditching by securing or jettisoning heavy objects located in the baggage area and collect folded coats for protection of occupants' face at touchdown. Transmit Mayday message on 121.5 MHz giving location and intentions and squawk 7700 if a transponder is installed. Avoid a landing flare because of difficulty in judging height over a water surface.

LANDING WITHOUT ELEVATOR CONTROL

Trim for horizontal flight with an airspeed of approximately 80 KIAS by using throttle and elevator trim control. Then do not change the elevator trim control setting; control the glide angle by adjusting power exclusively.

At flareout, the nose-down moment resulting from power reduction is an adverse factor and the airplane may hit on the nose wheel. Consequently, at flareout, the elevator trim control should be adjusted toward the full nose-up position and the power adjusted so that the airplane will rotate to the horizontal attitude for touchdown. Close the throttle at touchdown.

FIRES

Although engine fires are extremely rare in flight, the steps of the appropriate checklist should be followed if one is encountered. After completion of this procedure, execute a forced landing. Do not attempt to restart the engine.

The initial indication of an electrical fire is usually the odor of burning insulation. The checklist for this problem should result in elimination of the fire.

EMERGENCY OPERATION IN CLOUDS (Vacuum System Failure)

In the event of a vacuum system failure during flight, the directional indicator and attitude indicator will be disabled, and the pilot will have to rely on the turn coordinator if he inadvertently flies into clouds. The following instructions assume that only the electrically-powered turn coordinator is operative, and that the pilot is not completely proficient in instrument flying.

EXECUTING A 180° TURN IN CLOUDS

Upon inadvertently entering the clouds, an immediate plan should be made to turn back as follows:

1. Note the compass heading.
2. Note the time of the minute hand and observe the position of the sweep second hand on the clock.
3. When the sweep second hand indicates the nearest half-minute, initiate a standard rate left turn, holding the turn coordinator symbolic airplane wing opposite the lower left index mark for 60 seconds. Then roll back to level flight by leveling the miniature airplane.
4. Check accuracy of the turn by observing the compass heading which should be the reciprocal of the original heading.
5. If necessary, adjust heading primarily with skidding motions rather than rolling motions so that the compass will read more accurately.
6. Maintain altitude and airspeed by cautious application of elevator control. Avoid overcontrolling by keeping the hands off the control wheel as much as possible and steering only with rudder.

EMERGENCY DESCENT THROUGH CLOUDS

If conditions preclude reestablishment of VFR flight by a 180° turn, a descent through a cloud deck to VFR conditions may be appropriate. If possible, obtain radio clearance for an emergency descent through clouds. To guard against a spiral dive, choose an easterly or westerly heading to minimize compass card swings due to changing bank angles. In addition, keep hands off the control wheel and steer a straight course with rudder control by monitoring the turn coordinator. Occasionally check the compass heading and make minor corrections to hold an approximate course. Before descending into the clouds, set up a stabilized let-down condition as follows:

1. Apply full rich mixture.

2. Apply full carburetor heat.
3. Reduce power to set up a 500 to 800 ft/min rate of descent.
4. Adjust the elevator and rudder trim control wheels for a stabilized descent at 80 KIAS.
5. Keep hands off control wheel.
6. Monitor turn coordinator and make corrections by rudder alone.
7. Adjust rudder trim to relieve unbalanced rudder force, if present.
8. Check trend of compass card movement and make cautious corrections with rudder to stop turn.
9. Upon breaking out of clouds, resume normal cruising flight.

RECOVERY FROM A SPIRAL DIVE

If a spiral is encountered, proceed as follows:

1. Close the throttle.
2. Stop the turn by using coordinated aileron and rudder control to align the symbolic airplane in the turn coordinator with the horizon reference line.
3. Cautiously apply elevator back pressure to slowly reduce the indicated airspeed to 80 KIAS.
4. Adjust the elevator trim control to maintain an 80 KIAS glide.
5. Keep hands off the control wheel, using rudder control to hold a straight heading. Use rudder trim to relieve unbalanced rudder force, if present.
6. Apply carburetor heat.
7. Clear engine occasionally, but avoid using enough power to disturb the trimmed glide.
8. Upon breaking out of clouds, resume normal cruising flight.

INADVERTENT FLIGHT INTO ICING CONDITIONS

Flight into icing conditions is prohibited. An inadvertent encounter with these conditions can best be handled using the checklist procedures. The best procedure, of course, is to turn back or change altitude to escape icing conditions.

STATIC SOURCE BLOCKED

If erroneous readings of the static source instruments (airspeed, altimeter and rate-of-climb) are suspected, the alternate static source valve should be pulled on, thereby supplying static pressure to these instruments from the cabin. Cabin pressures will vary with open ventilators or windows and with airspeed. To avoid the possibility of large errors, the windows should not be open when using the alternate static source.

NOTE

In an emergency on airplanes not equipped with an alternate static source, cabin pressure can be supplied to the static pressure instruments by breaking the glass in the face of the rate-of-climb indicator.

A calibration table is provided in Section 5 to illustrate the effect of the alternate static source on indicated airspeeds. With the windows and vents closed the airspeed indicator may typically read as much as 3 knots faster and the altimeter 45 feet higher in cruise. With the vents open, this variation reduces to zero. If the alternate static source must be used for landing, the normal indicated approach speed may be used since the indicated airspeed variations in this configuration are 2 knots or less.

SPINS

Intentional spins are prohibited in this airplane. Should an inadvertent spin occur, the following recovery procedure should be used:

1. RETARD THROTTLE TO IDLE POSITION.
2. PLACE AILERONS IN NEUTRAL POSITION.
3. APPLY AND HOLD FULL RUDDER OPPOSITE TO THE DIRECTION OF ROTATION.
4. JUST AFTER THE RUDDER REACHES THE STOP, MOVE THE WHEEL BRISKLY FORWARD FAR ENOUGH TO BREAK THE STALL.
5. HOLD THESE CONTROL INPUTS UNTIL ROTATION STOPS. Premature relaxation of the control inputs may extend the recovery.
6. AS ROTATION STOPS, NEUTRALIZE RUDDER, AND MAKE A SMOOTH RECOVERY FROM THE RESULTING DIVE.

NOTE

If disorientation precludes a visual determination of the direction of rotation, the symbolic airplane in the turn coordinator may be referred to for this information.

ROUGH ENGINE OPERATION OR LOSS OF POWER

CARBURETOR ICING

An unexplained drop in manifold pressure and eventual engine

roughness may result from the formation of carburetor ice. To clear the ice, apply full throttle and pull the carburetor heat knob full out until the engine runs smoothly; then remove carburetor heat and readjust the throttle. If conditions require the continued use of carburetor heat in cruise flight, use the minimum amount of heat necessary to prevent ice from forming and lean the mixture for smoothest engine operation.

SPARK PLUG FOULING

A slight engine roughness in flight may be caused by one or more spark plugs becoming fouled by carbon or lead deposits. This may be verified by turning the ignition switch momentarily from BOTH to either L or R position. An obvious power loss in single ignition operation is evidence of spark plug or magneto trouble. Assuming that spark plugs are the more likely cause, lean the mixture to the recommended lean setting for cruising flight. If the problem does not clear up in several minutes, determine if a richer mixture setting will produce smoother operation. If not, proceed to the nearest airport for repairs using the BOTH position of the ignition switch unless extreme roughness dictates the use of a single ignition position.

MAGNETO MALFUNCTION

A sudden engine roughness or misfiring is usually evidence of magneto problems. Switching from BOTH to either L or R ignition switch position will identify which magneto is malfunctioning. Select different power settings and enrichen the mixture to determine if continued operation on BOTH magnetos is practicable. If not, switch to the good magneto and proceed to the nearest airport for repairs.

LOW OIL PRESSURE

If low oil pressure is accompanied by normal oil temperature, there is a possibility the oil pressure gage or relief valve is malfunctioning. A leak in the line to the gage is not necessarily cause for an immediate precautionary landing because an orifice in this line will prevent a sudden loss of oil from the engine sump. However, a landing at the nearest airport would be advisable to inspect the source of trouble.

If a total loss of oil pressure is accompanied by a rise in oil temperature, there is good reason to suspect an engine failure is imminent. Reduce engine power immediately and select a suitable forced landing field. Use only the minimum power required to reach the desired touchdown spot.

ELECTRICAL POWER SUPPLY SYSTEM MALFUNCTIONS

Malfunctions in the electrical power supply system can be detected by periodic monitoring of the ammeter and low-voltage warning light; however, the cause of these malfunctions is usually difficult to determine. A broken alternator drive belt or wiring is most likely the cause of alternator failures, although other factors could cause the problem. A damaged or improperly adjusted alternator control unit can also cause malfunctions. Problems of this nature constitute an electrical emergency and should be dealt with immediately. Electrical power malfunctions usually fall into two categories: excessive rate of charge and insufficient rate of charge. The paragraphs below describe the recommended remedy for each situation.

EXCESSIVE RATE OF CHARGE

After engine starting and heavy electrical usage at low engine speeds (such as extended taxiing) the battery condition will be low enough to accept above normal charging during the initial part of a flight. However, after thirty minutes of cruising flight, the ammeter should be indicating less than two needle widths of charging current. If the charging rate were to remain above this value on a long flight, the battery would overheat and evaporate the electrolyte at an excessive rate.

Electronic components in the electrical system can be adversely affected by higher than normal voltage. The alternator control unit includes an over-voltage sensor which normally will automatically shut down the alternator if the charge voltage reaches approximately 31.5 volts. If the over-voltage sensor malfunctions or is improperly adjusted, as evidenced by an excessive rate of charge shown on the ammeter, the alternator should be turned off, alternator circuit breaker pulled, nonessential electrical equipment turned off and the flight terminated as soon as practical.

INSUFFICIENT RATE OF CHARGE

NOTE

Illumination of the low-voltage light and ammeter discharge indications may occur during low RPM conditions with an electrical load on the system, such as during a low RPM taxi. Under these conditions, the light will go out at higher RPM. The master switch need not be recycled since an over-voltage condition has not occurred to de-activate the alternator system.

If the over-voltage sensor should shut down the alternator or if the alternator circuit breaker should trip, a discharge rate will be shown on the ammeter followed by illumination of the low-voltage warning light. Since this may be a "nuisance" trip-out, an attempt should be made to reactivate the alternator system. To do this, turn the avionics power switch off, check that the alternator circuit breaker is in, then turn both sides of the master switch off and then on again. If the problem no longer exists, normal alternator charging will resume and the low-voltage light will go off. The avionics power switch may then be turned back on. If the light illuminates again, a malfunction is confirmed. In this event, the flight should be terminated and/or the current drain on the battery minimized because the battery can supply the electrical system for only a limited period of time. If the emergency occurs at night, power must be conserved for later use of the landing lights and flaps during landing.

SECTION 4

NORMAL PROCEDURES

TABLE OF CONTENTS

	Page
Introduction	4-3
Speeds For Normal Operation	4-3

CHECKLIST PROCEDURES

Preflight Inspection	4-5
Cabin	4-5
Empennage	4-5
Right Wing, Trailing Edge	4-5
Right Wing	4-5
Nose	4-6
Left Wing	4-6
Left Wing, Leading Edge	4-6
Left Wing, Trailing Edge	4-6
Before Starting Engine	4-7
Starting Engine	4-7
Before Takeoff	4-7
Takeoff	4-8
Normal Takeoff	4-8
Short Field Takeoff	4-8
Enroute Climb	4-8
Normal Climb	4-8
Maximum Performance Climb	4-9
Cruise	4-9
Descent	4-9
Before Landing	4-9
Landing	4-10
Normal Landing	4-10
Short Field Landing	4-10
Balked Landing	4-10
After Landing	4-10
Securing Airplane	4-10

AMPLIFIED PROCEDURES

Starting Engine	4-13
---------------------------	------

TABLE OF CONTENTS (Continued)

	Page
Taxiing	4-13
Before Takeoff	4-15
Warm-Up	4-15
Magneto Check	4-15
Alternator Check	4-15
Takeoff	4-15
Power Check	4-15
Wing Flap Settings	4-16
Crosswind Takeoff	4-16
Enroute Climb	4-16
Cruise	4-17
Leaning With A Cessna Economy Mixture Indicator (EGT)	4-18
Stalls	4-19
Landing	4-19
Normal Landing	4-19
Short Field Landing	4-20
Crosswind Landing	4-20
Balked Landing	4-20
Cold Weather Operation	4-20
Starting	4-20
Operation	4-22
Hot Weather Operation	4-23
Noise Abatement	4-23

INTRODUCTION

Section 4 provides checklist and amplified procedures for the conduct of normal operation. Normal procedures associated with optional systems can be found in Section 9.

SPEEDS FOR NORMAL OPERATION

Unless otherwise noted, the following speeds are based on a maximum weight of 2950 pounds and may be used for any lesser weight. However, to achieve the performance specified in Section 5 for takeoff distance, the speed appropriate to the particular weight must be used.

Takeoff:

Normal Climb Out	70-80 KIAS
Short Field Takeoff, Flaps 20°, Speed at 50 Feet	57 KIAS

Enroute Climb, Flaps Up:

Normal	85-95 KIAS
Best Rate of Climb, Sea Level	78 KIAS
Best Rate of Climb, 10,000 Feet	72 KIAS
Best Angle of Climb, Sea Level	54 KIAS
Best Angle of Climb, 10,000 Feet	62 KIAS

Landing Approach:

Normal Approach, Flaps Up	70-80 KIAS
Normal Approach, Flaps 40°	60-70 KIAS
Short Field Approach, Flaps 40°	60 KIAS

Balked Landing:

Maximum Power, Flaps 20°	55 KIAS
------------------------------------	---------

Maximum Recommended Turbulent Air Penetration Speed:

2950 Lbs	111 KIAS
2450 Lbs	100 KIAS
1950 Lbs	89 KIAS

Maximum Demonstrated Crosswind Velocity:

Takeoff	20 KNOTS
Landing	15 KNOTS

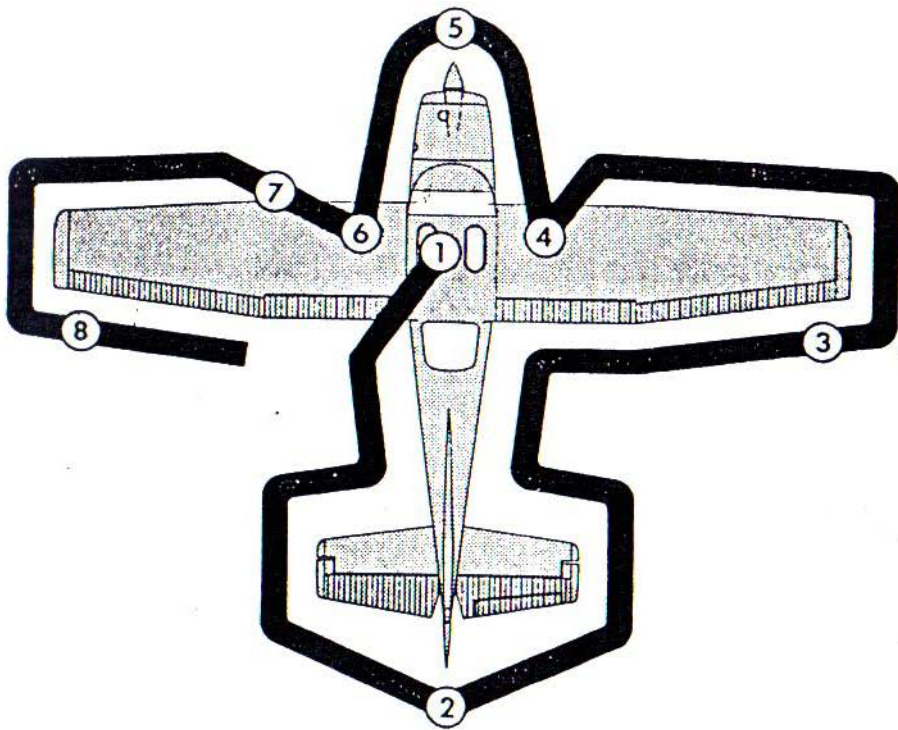

NOTE

Visually check airplane for general condition during walk-around inspection. In cold weather, remove even small accumulations of frost, ice or snow from wing, tail and control surfaces. Also, make sure that control surfaces contain no internal accumulations of ice or debris. Prior to flight, check that pitot heater (if installed) is warm to touch within 30 seconds with battery and pitot heat switches on. If a night flight is planned, check operation of all lights, and make sure a flashlight is available.

Figure 4-1. Preflight Inspection

CHECKLIST PROCEDURES

PREFLIGHT INSPECTION

① CABIN

1. Pilot's Operating Handbook -- AVAILABLE IN THE AIRPLANE.
2. Control Wheel Lock -- REMOVE.
3. Ignition Switch -- OFF.
4. Avionics Power Switch -- OFF.
5. Master Switch -- ON.

WARNING

When turning on the master switch, using an external power source, or pulling the propeller through by hand, treat the propeller as if the ignition switch were on. Do not stand, nor allow anyone else to stand, within the arc of the propeller, since a loose or broken wire, or a component malfunction, could cause the propeller to rotate.

6. Fuel Quantity Indicators -- CHECK QUANTITY.
7. Master Switch -- OFF.
8. Static Pressure Alternate Source Valve (if installed) -- OFF.
9. Fuel Selector Valve -- BOTH.
10. Baggage Door -- CHECK for security, lock with key if child's seat is to be occupied.

② EMPENNAGE

1. Rudder Gust Lock -- REMOVE.
2. Tail Tie-Down -- DISCONNECT.
3. Control Surfaces -- CHECK freedom of movement and security.

③ RIGHT WING Trailing Edge

1. Aileron -- CHECK freedom of movement and security.

④ RIGHT WING

1. Wing Tie-Down -- DISCONNECT.
2. Fuel Tank Vent Opening -- CHECK for stoppage.
3. Main Wheel Tire -- CHECK for proper inflation.

4. Before first flight of the day and after each refueling, use sampler cup and drain small quantity of fuel from fuel tank sump quick-drain valve to check for water, sediment, and proper fuel grade.
5. Fuel Quantity -- CHECK VISUALLY for desired level.
6. Fuel Filler Cap -- SECURE and vent unobstructed.

⑤ NOSE

1. Static Source Openings (both sides of fuselage) --CHECK for stoppage.
2. Propeller and Spinner -- CHECK for nicks, security and oil leaks.
3. Landing Lights -- CHECK for condition and cleanliness.
4. Carburetor Air Filter -- CHECK for restrictions by dust or other foreign matter.
5. Nose Wheel Strut and Tire -- CHECK for proper inflation.
6. Nose Tie-Down -- DISCONNECT.
7. Engine Oil Level -- CHECK. Do not operate with less than nine quarts. Fill to twelve quarts for extended flight.
8. Before first flight of the day and after each refueling, pull out strainer drain knob for about four seconds to clear fuel strainer of possible water and sediment. Check strainer drain closed. If water is observed, the fuel system may contain additional water, and further draining of the system at the strainer, fuel tank sumps, and fuel selector valve drain plug will be necessary.

⑥ LEFT WING

1. Main Wheel Tire -- CHECK for proper inflation.
2. Before first flight of day and after each refueling, use sampler cup and drain small quantity of fuel from fuel tank sump quick-drain valve to check for water, sediment and proper fuel grade.
3. Fuel Quantity -- CHECK VISUALLY for desired level.
4. Fuel Filler Cap -- SECURE and vent unobstructed.

⑦ LEFT WING Leading Edge

1. Pitot Tube Cover -- REMOVE and check opening for stoppage.
2. Fuel Tank Vent Opening -- CHECK for stoppage.
3. Stall Warning Vane -- CHECK for freedom of movement while master switch is momentarily turned ON (horn should sound when vane is pushed upward).
4. Wing Tie-Down -- DISCONNECT.

⑧ LEFT WING Trailing Edge

1. Aileron -- CHECK freedom of movement and security.

BEFORE STARTING ENGINE

1. Preflight Inspection -- COMPLETE.
2. Seats, Belts, Shoulder Harnesses -- ADJUST and LOCK.
3. Fuel Selector Valve -- BOTH.
4. Avionics Power Switch, Autopilot, (if installed) Electrical Equipment -- OFF.

CAUTION

The avionics power switch must be OFF during engine start to prevent possible damage to avionics.

5. Brakes -- TEST and SET.
6. Cowl Flaps -- OPEN (move lever out of locking hole to reposition).
7. Circuit Breakers -- CHECK IN.

STARTING ENGINE

1. Mixture -- RICH.
2. Propeller -- HIGH RPM.
3. Carburetor Heat -- COLD.
4. Throttle -- OPEN 1/2 INCH.
5. Prime -- AS REQUIRED.
6. Master Switch -- ON.
7. Propeller Area -- CLEAR.
8. Ignition Switch -- START (release when engine starts).

NOTE

If engine has been overprimed, start with throttle 1/4 to 1/2 open. Reduce throttle to idle when engine fires.

9. Oil Pressure -- CHECK.
10. Flashing Beacon and Navigation Lights -- ON as required.
11. Avionics Power Switch -- ON.
12. Radios -- ON.

BEFORE TAKEOFF

1. Cabin Doors and Windows -- CLOSED and LOCKED.
2. Parking Brake -- SET.
3. Flight Controls -- FREE and CORRECT.
4. Flight Instruments -- SET.
5. Fuel Selector Valve -- BOTH.
6. Mixture -- RICH.

SECTION 4
NORMAL PROCEDURES

CESSNA
MODEL 182Q

7. Elevator and Rudder Trim -- TAKEOFF.
8. Throttle -- 1700 RPM.
 - a. Magnetos -- CHECK (RPM drop should not exceed 150 RPM on either magneto or 50 RPM differential between magnetos).
 - b. Propeller -- CYCLE from high to low RPM; return to high RPM (full in).
 - c. Carburetor Heat -- CHECK (for RPM drop).
 - d. Engine Instruments and Ammeter -- CHECK.
 - e. Suction Gage -- CHECK.
9. Throttle -- 800 - 1000 RPM..
10. Radios -- SET.
11. Autopilot (if installed) -- OFF.
12. Strobe Lights -- AS DESIRED.
13. Throttle Friction Lock -- ADJUST.
14. Parking Brake -- RELEASE.

TAKEOFF

NORMAL TAKEOFF

1. Wing Flaps -- 0° - 20°.
2. Carburetor Heat -- COLD.
3. Power -- FULL THROTTLE and 2400 RPM.
4. Elevator Control -- LIFT NOSE WHEEL at 50 KIAS.
5. Climb Speed -- 70 KIAS (flaps 20°),
80 KIAS (flaps UP).

SHORT FIELD TAKEOFF

1. Wing Flaps -- 20°.
2. Carburetor Heat -- COLD.
3. Brakes -- APPLY.
4. Power -- FULL THROTTLE and 2400 RPM.
5. Brakes -- RELEASE.
6. Elevator Control -- MAINTAIN SLIGHTLY TAIL LOW ATTITUDE.
7. Climb Speed -- 57 KIAS (until all obstacles are cleared).
8. Wing Flaps -- RETRACT slowly after reaching 70 KIAS.

ENROUTE CLIMB

NORMAL CLIMB

1. Airspeed -- 85-95 KIAS.
2. Power -- 23 INCHES Hg and 2400 RPM.

3. Fuel Selector Valve -- BOTH.
4. Mixture -- FULL RICH (mixture may be leaned above 5000 feet).
5. Cowl Flaps -- OPEN as required.

MAXIMUM PERFORMANCE CLIMB

1. Airspeed -- 78 KIAS at sea level to 72 KIAS at 10,000 feet.
2. Power -- FULL THROTTLE and 2400 RPM.
3. Fuel Selector Valve -- BOTH.
4. Mixture -- FULL RICH (mixture may be leaned above 5000 feet).
5. Cowl Flaps -- FULL OPEN.

CRUISE

1. Power -- 15-23 INCHES Hg, 2100-2400 RPM (no more than 75% power).
2. Elevator and Rudder Trim -- ADJUST.
3. Mixture -- LEAN.
4. Cowl Flaps -- CLOSED.

DESCENT

1. Fuel Selector Valve -- BOTH.
2. Power -- AS DESIRED.
3. Carburetor Heat -- FULL HEAT AS REQUIRED to prevent carburetor icing.
4. Mixture -- ENRICHEN as required.
5. Cowl Flaps -- CLOSED.
6. Wing Flaps -- AS DESIRED (0° - 10° below 140 KIAS, 10° - 40° below 95 KIAS).

BEFORE LANDING

1. Seats, Belts, Harnesses -- ADJUST and LOCK.
2. Fuel Selector Valve -- BOTH.
3. Mixture -- RICH.
4. Carburetor Heat -- ON (apply full heat before reducing power).
5. Propeller -- HIGH RPM.
6. Autopilot (if installed) -- OFF.

LANDING

NORMAL LANDING

1. Airspeed -- 70-80 KIAS (flaps UP).
2. Wing Flaps -- AS DESIRED (0° - 10° below 140 KIAS, 10° - 40° below 95 KIAS).
3. Airspeed -- 60-70 KIAS (flaps DOWN).
4. Trim -- ADJUST.
5. Touchdown -- MAIN WHEELS FIRST.
6. Landing Roll -- LOWER NOSE WHEEL GENTLY.
7. Braking -- MINIMUM REQUIRED.

SHORT FIELD LANDING

1. Airspeed -- 70-80 KIAS (flaps UP).
2. Wing Flaps -- 40° (below 95 KIAS).
3. Airspeed -- MAINTAIN 60 KIAS.
4. Trim -- ADJUST.
5. Power -- REDUCE to idle as obstacle is cleared.
6. Touchdown -- MAIN WHEELS FIRST.
7. Brakes -- APPLY HEAVILY.
8. Wing Flaps -- RETRACT for maximum brake effectiveness.

BALKED LANDING

1. Power -- FULL THROTTLE and 2400 RPM.
2. Carburetor Heat -- COLD.
3. Wing Flaps -- RETRACT to 20°.
4. Climb Speed -- 55 KIAS.
5. Wing Flaps -- RETRACT slowly after reaching 70 KIAS.
6. Cowl Flaps -- OPEN.

AFTER LANDING

1. Wing Flaps -- UP.
2. Carburetor Heat -- COLD.
3. Cowl Flaps -- OPEN.

SECURING AIRPLANE

1. Parking Brake -- SET.
2. Avionics Power Switch, Electrical Equipment -- OFF.

3. Throttle -- IDLE.
4. Mixture -- IDLE CUT-OFF (pulled full out).
5. Ignition Switch -- OFF.
6. Master Switch -- OFF.
7. Control Lock -- INSTALL.
8. Fuel Selector Valve -- RIGHT.

AMPLIFIED PROCEDURES

STARTING ENGINE

Ordinarily the engine starts easily with one or two strokes of the primer in warm temperatures to six strokes in cold weather with the throttle open approximately 1/2 inch. In extremely cold temperatures, it may be necessary to continue priming while cranking. Weak intermittent firing followed by puffs of black smoke from the exhaust stack indicates overpriming or flooding. Excess fuel can be cleared from the combustion chambers by the following procedure: Set the mixture control full lean and the throttle full open; then crank the engine through several revolutions with the starter. Repeat the starting procedure without any additional priming.

If the engine is underprimed (most likely in cold weather with a cold engine) it will not fire at all. Additional priming will be necessary for the next starting attempt. As soon as the cylinders begin to fire, open the throttle slightly to keep it running.

If prolonged cranking is necessary, allow the starter motor to cool at frequent intervals, since excessive heat may damage the armature.

After starting, if the oil gage does not begin to show pressure within 30 seconds in the summertime and about twice that long in very cold weather, stop engine and investigate. Lack of oil pressure can cause serious engine damage. After starting, avoid the use of carburetor heat unless icing conditions prevail.

NOTE

Additional details concerning cold weather starting and operation may be found under COLD WEATHER OPERATION paragraphs in this section.

TAXIING

When taxiing, it is important that speed and use of brakes be held to a minimum and that all controls be utilized (see Taxiing Diagram, figure 4-2) to maintain directional control and balance.

The carburetor heat control knob should be pushed full in during all ground operations unless heat is absolutely necessary for smooth engine operation. When the knob is pulled out to the heat position, air entering the engine is not filtered.

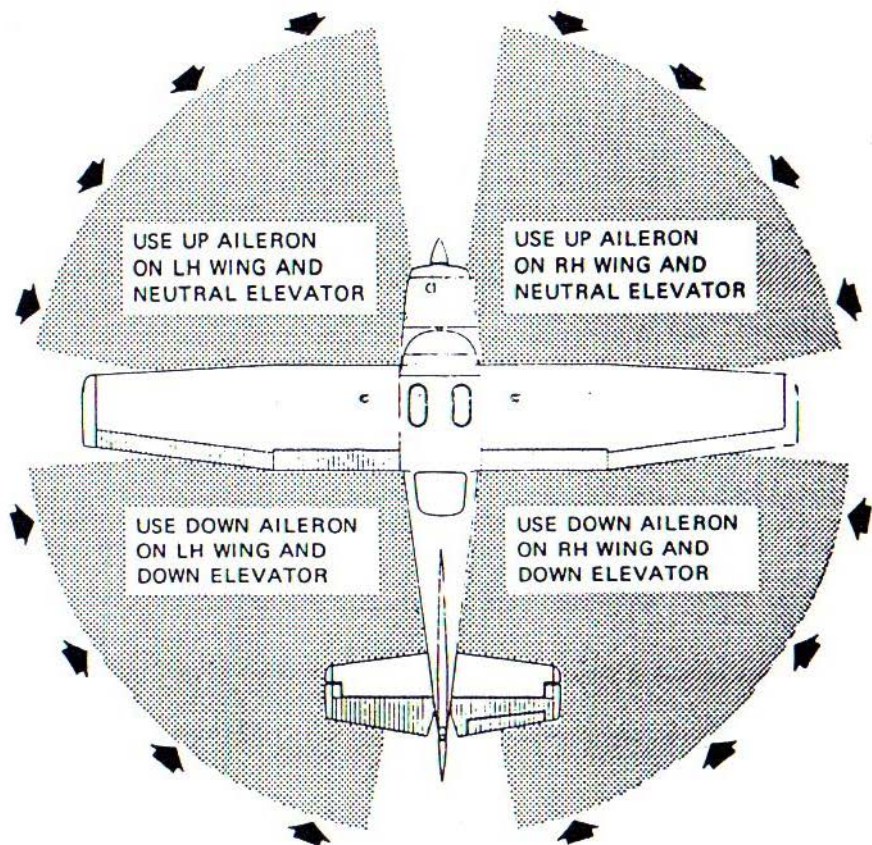

CODE
WIND DIRECTION →

NOTE

Strong quartering tail winds require caution. Avoid sudden bursts of the throttle and sharp braking when the airplane is in this attitude. Use the steerable nose wheel and rudder to maintain direction.

Figure 4-2. Taxiing Diagram

Taxiing over loose gravel or cinders should be done at low engine speed to avoid abrasion and stone damage to the propeller tips.

BEFORE TAKEOFF

WARM-UP

Since the engine is closely cowled for efficient in-flight cooling, precautions should be taken to avoid overheating on the ground. Full power checks on the ground are not recommended unless the pilot has good reason to suspect that the engine is not turning up properly.

MAGNETO CHECK

The magneto check should be made at 1700 RPM as follows. Move ignition switch first to R position and note RPM. Next move switch back to BOTH to clear the other set of plugs. Then move switch to the L position, note RPM and return the switch to the BOTH position. RPM drop should not exceed 150 RPM on either magneto or show greater than 50 RPM differential between magnetos. If there is a doubt concerning operation of the ignition system, RPM checks at higher engine speeds will usually confirm whether a deficiency exists.

An absence of RPM drop may be an indication of faulty grounding of one side of the ignition system or should be cause for suspicion that the magneto timing is set in advance of the setting specified.

ALTERNATOR CHECK

Prior to flights where verification of proper alternator and alternator control unit operation is essential (such as night or instrument flights), a positive verification can be made by loading the electrical system momentarily (3 to 5 seconds) with the landing light during the engine runup (1700 RPM). The ammeter will remain within a needle width of the initial reading if the alternator and alternator control unit are operating properly.

TAKEOFF

POWER CHECK

It is important to check takeoff power early in the takeoff run. Any sign of rough engine operation or sluggish engine acceleration is good cause for discontinuing the takeoff.

Full power runups over loose gravel are especially harmful to pro-

propeller tips. When takeoffs must be made over a gravel surface, it is very important that the throttle be advanced slowly. This allows the airplane to start rolling before high RPM is developed, and the gravel will be blown back of the propeller rather than pulled into it. When unavoidable small dents appear in the propeller blades they should be corrected immediately as described in Section 8 under Propeller Care.

After full power is applied, adjust the throttle friction lock clockwise to prevent the throttle from creeping from a maximum power position. Similar friction lock adjustment should be made as required in other flight conditions to maintain a fixed throttle setting.

WING FLAP SETTINGS

Normal takeoffs are accomplished with wing flaps 0° to 20°. Using 20° wing flaps reduces the ground run and total distance over an obstacle by approximately 20 per cent. Flap deflections greater than 20° are not approved for takeoff.

If 20° wing flaps are used for takeoff, they should be left down until all obstacles are cleared and a safe flap retraction speed of 70 KIAS is reached. To clear an obstacle with wing flaps 20°, an obstacle clearance speed of 57 KIAS should be used.

Soft field takeoffs are performed with 20° flaps by lifting the airplane off the ground as soon as practical in a slightly tail-low attitude. If no obstacles are ahead, the airplane should be leveled off immediately to accelerate to a safer climb speed.

With wing flaps retracted and no obstructions ahead, a climb-out speed of 80 KIAS would be most efficient.

CROSSWIND TAKEOFF

Takeoffs into strong crosswinds normally are performed with the minimum flap setting necessary for the field length, to minimize the drift angle immediately after takeoff. With the ailerons partially deflected into the wind, the airplane is accelerated to a speed slightly higher than normal, and then pulled off abruptly to prevent possible settling back to the runway while drifting. When clear of the ground, make a coordinated turn into the wind to correct for drift.

ENROUTE CLIMB

Normal climbs are performed at 85-95 KIAS with flaps up, 23 In. Hg. or full throttle (whichever is less) and 2400 RPM for the best combination of

engine cooling, rate of climb and forward visibility. If it is necessary to climb rapidly to clear mountains or reach favorable winds at high altitudes, the best rate-of-climb speed should be used with maximum power. This speed is 78 KIAS at sea level, decreasing to 72 KIAS at 10,000 feet.

If an obstruction ahead requires a steep climb angle, a best angle-of-climb speed should be used with flaps up and maximum power. This speed is 54 KIAS at sea level, increasing to 62 KIAS at 10,000 feet.

The mixture should be full rich during climb at altitudes up to 5000 feet. Above 5000 feet, the mixture may be leaned for smooth engine operation and increased power.

CRUISE

Normal cruising is performed between 55% and 75% power. The corresponding power settings and fuel consumption for various altitudes can be determined by using your Cessna Power Computer or the data in Section 5.

NOTE

Cruising should be done at 75% power as much as practical until a total of 50 hours has accumulated or oil consumption has stabilized. This is to ensure proper seating of the rings and is applicable to new engines, and engines in service following cylinder replacement or top overhaul of one or more cylinders.

The Cruise Performance Table, figure 4-3, illustrates the true airspeed and nautical miles per gallon during cruise for various altitudes and percent powers. This table should be used as a guide, along with the available winds aloft information, to determine the most favorable altitudes and power setting for a given trip. The selection of cruise altitude on the basis of the most favorable wind conditions and the use of low power settings are significant factors that should be considered on every trip to reduce fuel consumption.

For reduced noise levels, it is desirable to select the lowest RPM in the green arc range for a given percent power that will provide smooth engine operation. The cowl flaps should be opened, if necessary, to maintain the cylinder head temperature at approximately two-thirds of the normal operating range (green arc).

ALTITUDE	75% POWER		65% POWER		55% POWER	
	KTAS	NMPG	KTAS	NMPG	KTAS	NMPG
4000 Feet	139	10.8	131	11.8	121	12.8
6000 Feet	141	11.0	133	12.0	123	13.0
8000 Feet	144	11.2	135	12.2	125	13.2
10,000 Feet	---	---	138	12.4	127	13.4
Standard Conditions					Zero Wind	

Figure 4-3. Cruise Performance Table

Cruise performance data in this handbook and on the power computer is based on a recommended lean mixture setting which may be established as follows:

1. Lean the mixture until the engine becomes rough.
2. Enrichen the mixture to obtain smooth engine operation; then further enrichen an equal amount.

For best fuel economy at 65% power or less, the engine may be operated at the leanest mixture that results in smooth engine operation. This will result in approximately 5% greater range than shown in this handbook accompanied by approximately a 3 knot decrease in speed.

Any change in altitude, power or carburetor heat will require a change in the recommended lean mixture setting and a recheck of the EGT setting (if installed).

Carburetor ice, as evidenced by an unexplained drop in manifold pressure, can be removed by application of full carburetor heat. Upon regaining the original manifold pressure indication (with heat off), use the minimum amount of heat (by trial and error) to prevent ice from forming. Since the heated air causes a richer mixture, readjust the mixture setting when carburetor heat is to be used continuously in cruise flight.

The use of full carburetor heat is recommended during flight in very heavy rain to avoid the possibility of engine stoppage due to excessive water ingestion. The mixture setting should be readjusted for smoothest operation.

LEANING WITH A CESSNA ECONOMY MIXTURE INDICATOR (EGT)

Exhaust gas temperature (EGT) as shown on the optional Cessna

MIXTURE DESCRIPTION	EXHAUST GAS TEMPERATURE
RECOMMENDED LEAN (Pilot's Operating Handbook and Power Computer)	50°F Rich of Peak EGT
BEST ECONOMY (65% Power or Less)	Peak EGT

Figure 4-4. EGT Table

Economy Mixture Indicator may be used as an aid for mixture leaning in cruising flight at 75% power or less. To adjust the mixture, using this indicator, lean to establish the peak EGT as a reference point and then enrichen the mixture by a desired increment based on data in figure 4-4.

Continuous operation at peak EGT is authorized only at 65% power or less. This best economy mixture setting results in approximately 5% greater range than shown in this handbook accompanied by approximately a 3 knot decrease in speed.

NOTE

Operation on the lean side of peak EGT is not approved.

When leaning the mixture under some conditions, engine roughness may occur before peak EGT is reached. In this case, use the EGT corresponding to the onset of roughness as the reference point instead of peak EGT.

STALLS

The stall characteristics are conventional and aural warning is provided by a stall warning horn which sounds between 5 and 10 knots above the stall in all configurations.

Power-off stall speeds at maximum weight for both forward and aft C.G. are presented in Section 5.

LANDING

NORMAL LANDING

Landings should be made on the main wheels first to reduce the

landing speed and the subsequent need for braking in the landing roll. The nose wheel is lowered gently to the runway after the speed has diminished to avoid unnecessary nose gear load. This procedure is especially important in rough field landings.

SHORT FIELD LANDING

For a short field landing, make a power-off approach at 60 KIAS with 40° flaps and land on the main wheels first. Immediately after touchdown, lower the nose gear to the ground and apply heavy braking as required. For maximum brake effectiveness after all three wheels are on the ground, retract the flaps, hold full nose up elevator and apply maximum possible brake pressure without sliding the tires.

CROSSWIND LANDING

When landing in a strong crosswind, use the minimum flap setting required for the field length. Although the crab or combination method of drift correction may be used, the wing-low method gives the best control. After touchdown, hold a straight course with the steerable nose wheel and occasional braking if necessary.

BALKED LANDING

In a bailed landing (go-around) climb, the wing flap setting should be reduced to 20° immediately after full power is applied. After all obstacles are cleared and a safe altitude and airspeed are obtained, the wing flaps should be retracted.

COLD WEATHER OPERATION

STARTING

Prior to starting on cold mornings, it is advisable to pull the propeller through several times by hand to "break loose" or "limber" the oil, thus conserving battery energy.

NOTE

When pulling the propeller through by hand, treat it as if the ignition switch is turned on. A loose or broken ground wire on either magneto could cause the engine to fire.

In extremely cold (-18°C and lower) weather, the use of an external preheater and an external power source are recommended whenever

possible to obtain positive starting and to reduce wear and abuse to the engine and the electrical system. Pre-heat will thaw the oil trapped in the oil cooler, which probably will be congealed prior to starting in extremely cold temperatures. When using an external power source, the position of the master switch is important. Refer to Section 9, Supplements, for Ground Service Plug Receptacle operating details.

Cold weather starting procedures are as follows:

With Preheat:

1. With ignition switch turned OFF, mixture full rich and throttle open 1/2 inch, prime the engine four to eight strokes as the propeller is being turned over by hand.

NOTE

Use heavy strokes of the primer for best atomization of fuel. After priming, push primer all the way in and turn to the locked position to avoid the possibility of the engine drawing fuel through the primer.

2. Propeller -- CLEAR.
3. Avionics Power Switch -- OFF.
4. Master Switch -- ON.
5. Ignition Switch -- START (release to BOTH when engine starts).
6. Pull carburetor heat on after engine has started, and leave on until the engine is running smoothly.

Without Preheat:

1. Prime the engine six to eight strokes while the propeller is being turned by hand with mixture full rich and throttle open 1/2 inch. Leave the primer charged and ready for stroke.
2. Propeller -- CLEAR.
3. Avionics Power Switch -- OFF.
4. Master Switch -- ON.
5. Ignition Switch -- START.
6. Pump throttle rapidly to full open twice. Return to 1/2 inch open position.
7. Release ignition switch to BOTH when engine starts.
8. Continue to prime engine until it is running smoothly, or alternately, pump the throttle rapidly over first 1/4 of total travel.
9. Oil Pressure -- CHECK.
10. Pull carburetor heat knob full on after engine has started. Leave on until engine is running smoothly.
11. Primer -- LOCK.

NOTE

If the engine does not start during the first few attempts, or if engine firing diminishes in strength, it is probable that the spark plugs have been frosted over. Preheat must be used before another start is attempted.

CAUTION

Pumping the throttle may cause raw fuel to accumulate in the intake air duct, creating a fire hazard in the event of a backfire. If this occurs, maintain a cranking action to suck flames into the engine. An outside attendant with a fire extinguisher is advised for cold starts without preheat.

OPERATION

During cold weather operations, no indication will be apparent on the oil temperature gage prior to takeoff if outside air temperatures are very cold. After a suitable warm-up period (2 to 5 minutes at 1000 RPM), accelerate the engine several times to higher engine RPM. If the engine accelerates smoothly and the oil pressure remains normal and steady, the airplane is ready for takeoff.

Rough engine operation in cold weather can be caused by a combination of an inherently leaner mixture due to the dense air and poor vaporization and distribution of the fuel-air mixture to the cylinders. The effects of these conditions are especially noticeable during operation on one magneto in ground checks where only one spark plug fires in each cylinder.

For optimum operation of the engine in cold weather, the appropriate use of carburetor heat is recommended. The following procedures are indicated as a guideline:

1. Use carburetor heat during engine warm-up and ground check. Full carburetor heat may be required for temperatures below -12°C whereas partial heat could be used in temperatures between -12°C and 4°C .
2. Use the minimum carburetor heat required for smooth operation in take-off, climb, and cruise.

NOTE

Care should be exercised when using partial carburetor heat to avoid icing. Partial heat may raise the carburetor air temperature to 0° to 21°C range where icing is critical under certain atmospheric conditions.

3. If the airplane is equipped with a carburetor air temperature gage, it can be used as a reference in maintaining carburetor air temperature at or slightly above the top of the yellow arc by application of carburetor heat.

HOT WEATHER OPERATION

The general warm temperature starting information in this section is appropriate. Avoid prolonged engine operation on the ground.

NOISE ABATEMENT

Increased emphasis on improving the quality of our environment requires renewed effort on the part of all pilots to minimize the effect of airplane noise on the public.

We, as pilots, can demonstrate our concern for environmental improvement, by application of the following suggested procedures, and thereby tend to build public support for aviation:

1. Pilots operating aircraft under VFR over outdoor assemblies of persons, recreational and park areas, and other noise-sensitive areas should make every effort to fly not less than 2000 feet above the surface, weather permitting, even though flight at a lower level may be consistent with the provisions of government regulations.
2. During departure from or approach to an airport, climb after takeoff and descent for landing should be made so as to avoid prolonged flight at low altitude near noise-sensitive areas.

NOTE

The above recommended procedures do not apply where they would conflict with Air Traffic Control clearances or instructions, or where, in the pilot's judgment, an altitude of less than 2000 feet is necessary for him to adequately exercise his duty to see and avoid other aircraft.

The certificated noise level for the Model 182Q at 2950 pounds maximum weight is 69.1 dB(A). No determination has been made by the Federal Aviation Administration that the noise levels of this airplane are or should be acceptable or unacceptable for operation at, into, or out of, any airport.

SECTION 5 PERFORMANCE



TABLE OF CONTENTS

	Page
Introduction	5-3
Use of Performance Charts	5-3
Sample Problem	5-3
Takeoff	5-4
Cruise	5-5
Fuel Required	5-5
Landing	5-7
Demonstrated Operating Temperature	5-7
Figure 5-1, Airspeed Calibration - Normal Static Source	5-8
Airspeed Calibration - Alternate Static Source	5-9
Figure 5-2, Temperature Conversion Chart	5-10
Figure 5-3, Stall Speeds	5-11
Figure 5-4, Takeoff Distance - 2950 Lbs	5-12
Takeoff Distance - 2700 Lbs and 2400 Lbs	5-13
Figure 5-5, Maximum Rate Of Climb	5-14
Figure 5-6, Time, Fuel, And Distance To Climb - Maximum Rate of Climb	5-15
Time, Fuel, and Distance to Climb - Normal Climb	5-16
Figure 5-7, Cruise Performance - 2000 Feet	5-17
Cruise Performance - 4000 Feet	5-18
Cruise Performance - 6000 Feet	5-19
Cruise Performance - 8000 Feet	5-20
Cruise Performance - 10,000 Feet	5-21
Cruise Performance - 12,000 Feet	5-22
Cruise Performance - 14,000 Feet	5-23
Cruise Performance - 16,000 Feet	5-24
Figure 5-8, Range Profile - 65 Gallons Fuel	5-25
Range Profile - 88 Gallons Fuel	5-26
Figure 5-9, Endurance Profile - 65 Gallons Fuel	5-27
Endurance Profile - 88 Gallons Fuel	5-28
Figure 5-10, Landing Distance	5-28

INTRODUCTION

Performance data charts on the following pages are presented so that you may know what to expect from the airplane under various conditions, and also, to facilitate the planning of flights in detail and with reasonable accuracy. The data in the charts has been computed from actual flight tests with the airplane and engine in good condition and using average piloting techniques.

It should be noted that the performance information presented in the range and endurance profile charts allows for 45 minutes reserve fuel at the specified cruise power. Fuel flow data for cruise is based on the recommended lean mixture setting. Some indeterminate variables such as mixture leaning technique, fuel metering characteristics, engine and propeller condition, and air turbulence may account for variations of 10% or more in range and endurance. Therefore, it is important to utilize all available information to estimate the fuel required for the particular flight.

USE OF PERFORMANCE CHARTS

Performance data is presented in tabular or graphical form to illustrate the effect of different variables. Sufficiently detailed information is provided in the tables so that conservative values can be selected and used to determine the particular performance figure with reasonable accuracy.

SAMPLE PROBLEM

The following sample flight problem utilizes information from the various charts to determine the predicted performance data for a typical flight. The following information is known:

AIRPLANE CONFIGURATION

Takeoff weight	2900 Pounds
Usable fuel	65 Gallons

TAKEOFF CONDITIONS

Field pressure altitude	1500 Feet
Temperature	28°C (16°C above standard)
Wind component along runway	12 Knot Headwind
Field length	3500 Feet

SECTION 5
PERFORMANCE

CESSNA
MODEL 182Q

CRUISE CONDITIONS

Total distance	450 Nautical Miles
Pressure altitude	7500 Feet
Temperature	16°C (16°C above standard)
Expected wind enroute	10 Knot Headwind

LANDING CONDITIONS

Field pressure altitude	2000 Feet
Temperature	25°C
Field length	3000 Feet

TAKEOFF

The takeoff distance chart, figure 5-4, should be consulted, keeping in mind that the distances shown are based on the short field technique. Conservative distances can be established by reading the chart at the next higher value of weight, altitude and temperature. For example, in this particular sample problem, the takeoff distance information presented for a weight of 2950 pounds, pressure altitude of 2000 feet and a temperature of 30°C should be used and results in the following:

Ground roll	930 Feet
Total distance to clear a 50-foot obstacle	1800 Feet

These distances are well within the available takeoff field length. However, a correction for the effect of wind may be made based on Note 3 of the takeoff chart. The correction for a 12 knot headwind is:

$$\frac{12 \text{ Knots}}{9 \text{ Knots}} \times 10\% = 13\% \text{ Decrease}$$

This results in the following distances, corrected for wind:

Ground roll, zero wind	930
Decrease in ground roll (930 feet × 13%)	<u>121</u>
Corrected ground roll	809 Feet
Total distance to clear a 50-foot obstacle, zero wind	1800
Decrease in total distance (1800 feet × 13%)	<u>234</u>
Corrected total distance to clear 50-foot obstacle	1566 Feet

CRUISE

The cruising altitude should be selected based on a consideration of trip length, winds aloft, and the airplane's performance. A cruising altitude and the expected wind enroute have been given for this sample problem. However, the power setting selection for cruise must be determined based on several considerations. These include the cruise performance characteristics presented in figure 5-7, the range profile chart presented in figure 5-8, and the endurance profile chart presented in figure 5-9.

The relationship between power and range is illustrated by the range profile chart. Considerable fuel savings and longer range result when lower power settings are used. For this sample problem, a cruise power of approximately 65% will be used.

The cruise performance chart for 8,000 feet pressure altitude is entered using 20°C above standard temperature. These values most nearly correspond to the planned altitude and expected temperature conditions. The power setting chosen is 2200 RPM and 21 inches of manifold pressure, which results in the following:

Power	65%
True airspeed	137 Knots
Cruise fuel flow	11.0 GPH

The power computer may be used to determine power and fuel consumption more accurately during the flight.

FUEL REQUIRED

The total fuel requirement for the flight may be estimated using the performance information in figures 5-6 and 5-7. For this sample problem, figure 5-6 shows that a normal climb from 2000 feet to 8000 feet requires 2.8 gallons of fuel. The corresponding distance during the climb is 15 nautical miles. These values are for a standard temperature and are sufficiently accurate for most flight planning purposes. However, a further correction for the effect of temperature may be made as noted on the climb chart. The approximate effect of a non-standard temperature is to increase the time, fuel, and distance by 10% for each 10°C above standard temperature, due to the lower rate of climb. In this case, assuming a temperature 16°C above standard, the correction would be:

$$\frac{16^{\circ}\text{C}}{10^{\circ}\text{C}} \times 10\% = 16\% \text{ Increase}$$

With this factor included, the fuel estimate would be calculated as follows:

SECTION 5
PERFORMANCE

CESSNA
MODEL 182Q

Fuel to climb, standard temperature	2.8
Increase due to non-standard temperature (2.8 × 16%)	<u>0.4</u>
Corrected fuel to climb	3.2 Gallons

Using a similar procedure for the distance during climb results in 17 nautical miles.

The resultant cruise distance is:

Total distance	450
Climb distance	<u>-17</u>
Cruise distance	433 Nautical Miles

With an expected 10 knot headwind, the ground speed for cruise is predicted to be:

137
<u>-10</u>
127 Knots

Therefore, the time required for the cruise portion of the trip is:

$$\frac{433 \text{ Nautical Miles}}{127 \text{ Knots}} = 3.4 \text{ Hours}$$

The fuel required for cruise is:

$$3.4 \text{ hours} \times 11.0 \text{ gallons/hour} = 37.4 \text{ Gallons}$$

A 45-minute reserve requires:

$$\frac{45}{60} \times 11.0 \text{ gallons/hour} = 8.3 \text{ Gallons}$$

The total estimated fuel required is as follows:

Engine start, taxi, and takeoff	1.7
Climb	3.2
Cruise	37.4
Reserve	<u>8.3</u>
Total fuel required	50.6 Gallons

Once the flight is underway, ground speed checks will provide a more accurate basis for estimating the time enroute and the corresponding fuel required to complete the trip with ample reserve.

LANDING

A procedure similar to takeoff should be used for estimating the landing distance at the destination airport. Figure 5-10 presents landing distance information for the short field technique. The distances corresponding to 2000 feet pressure altitude and a temperature of 30°C are as follows:

Ground roll	670 Feet
Total distance to clear a 50-foot obstacle	1480 Feet

A correction for the effect of wind may be made based on Note 2 of the landing chart using the same procedure as outlined for takeoff.

DEMONSTRATED OPERATING TEMPERATURE

Satisfactory engine cooling has been demonstrated for this airplane with an outside air temperature 23°C above standard. This is not to be considered as an operating limitation. Reference should be made to Section 2 for engine operating limitations.

**AIRSPEED CALIBRATION
ALTERNATE STATIC SOURCE**

HEATER/VENTS AND WINDOWS CLOSED

FLAPS UP											
NORMAL KIAS	60	70	80	90	100	110	120	130	140	150	160
ALTERNATE KIAS	59	70	80	91	102	112	122	133	143	153	163
FLAPS 20°											
NORMAL KIAS	50	60	70	80	90	95	---	---	---	---	---
ALTERNATE KIAS	51	62	72	82	92	97	---	---	---	---	---
FLAPS 40°											
NORMAL KIAS	40	50	60	70	80	90	95	---	---	---	---
ALTERNATE KIAS	43	51	60	71	81	90	95	---	---	---	---

HEATER/VENTS OPEN AND WINDOWS CLOSED

FLAPS UP											
NORMAL KIAS	60	70	80	90	100	110	120	130	140	150	160
ALTERNATE KIAS	60	70	80	90	100	110	120	130	140	150	160
FLAPS 20°											
NORMAL KIAS	50	60	70	80	90	95	---	---	---	---	---
ALTERNATE KIAS	50	60	70	79	89	93	---	---	---	---	---
FLAPS 40°											
NORMAL KIAS	40	50	60	70	80	90	95	---	---	---	---
ALTERNATE KIAS	41	49	59	68	78	87	92	---	---	---	---

Figure 5-1. Airspeed Calibration (Sheet 2 of 2)

TEMPERATURE CONVERSION CHART

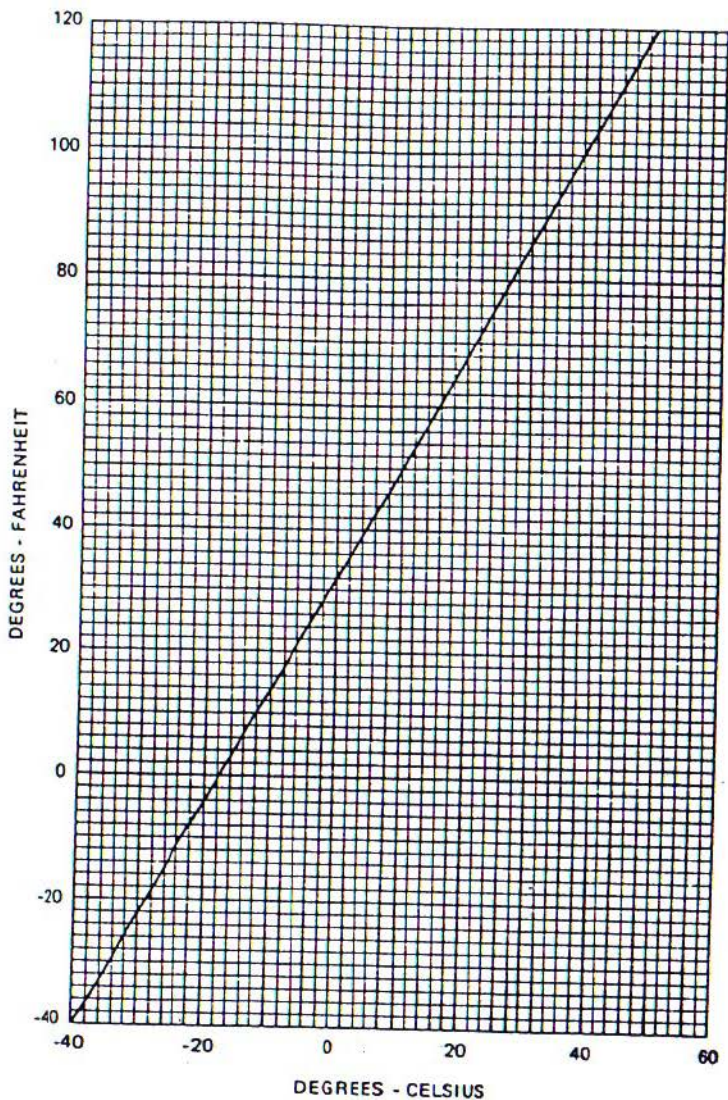

Figure 5-2. Temperature Conversion Chart

STALL SPEEDS

CONDITIONS:
Power Off

NOTES:

1. Maximum altitude loss during a stall recovery may be as much as 160 feet.
2. KIAS values are approximate.

MOST REARWARD CENTER OF GRAVITY

WEIGHT LBS	FLAP DEFLECTION	ANGLE OF BANK							
		0°		30°		45°		60°	
		KIAS	KCAS	KIAS	KCAS	KIAS	KCAS	KIAS	KCAS
2950	UP	41	56	44	60	49	67	58	79
	20°	38	51	41	55	45	61	54	72
	40°	38	50	41	54	45	59	54	71

MOST FORWARD CENTER OF GRAVITY

WEIGHT LBS	FLAP DEFLECTION	ANGLE OF BANK							
		0°		30°		45°		60°	
		KIAS	KCAS	KIAS	KCAS	KIAS	KCAS	KIAS	KCAS
2950	UP	48	59	52	63	57	70	68	83
	20°	47	55	51	59	56	65	66	78
	40°	45	54	48	58	54	64	64	76

Figure 5-3. Stall Speeds

TAKEOFF DISTANCE
MAXIMUM WEIGHT 2950 LBS

SHORT FIELD

CONDITIONS:

- Flaps 20°
- 2400 RPM, Full Throttle and Mixture Set Prior to Brake Release
- Cowl Flaps Open
- Paved, Level, Dry Runway
- Zero Wind

NOTES:

1. Short field technique as specified in Section 4.
2. Prior to takeoff from fields above 5000 feet elevation, the mixture should be leaned to give maximum power in a full throttle, static runup.
3. Decrease distances 10% for each 9 knots headwind. For operation with tailwinds up to 10 knots, increase distances by 10% for each 2 knots.
4. Where distance value has been deleted, climb performance after lift-off is less than 150 fpm at takeoff speed.
5. For operation on a dry, grass runway, increase distances by 15% of the "ground roll" figure.

WEIGHT LBS	TAKEOFF SPEED KIAS		PRESS ALT FT	0°C			10°C			20°C			30°C			40°C			
	LIFT OFF	AT 50 FT		GRND ROLL	TO CLEAR 50 FT OBS	TOTAL	GRND ROLL	TO CLEAR 50 FT OBS	TOTAL	GRND ROLL	TO CLEAR 50 FT OBS	TOTAL	GRND ROLL	TO CLEAR 50 FT OBS	TOTAL	GRND ROLL	TO CLEAR 50 FT OBS	TOTAL	
2950	49	57	S.L.	635	1220	680	1305	730	1395	780	1490	835	1590	835	1590	835	1590	835	1590
			1000	690	1335	745	1430	795	1530	850	1635	910	1745	910	1745	910	1745	910	1745
			2000	755	1465	810	1565	870	1680	930	1800	995	1925	995	1925	995	1925	995	1925
			3000	825	1605	890	1725	950	1850	1020	1985	1090	2130	1090	2130	1090	2130	1090	2130
			4000	905	1770	970	1905	1045	2050	1120	2205	1195	2370	1195	2370	1195	2370	1195	2370
			5000	995	1965	1065	2115	1145	2280	1230	2460	1315	2655	1315	2655	1315	2655	1315	2655
			6000	1090	2185	1175	2360	1260	2555	1350	2765	1450	3005	1450	3005	1450	3005	1450	3005
			7000	1200	2450	1290	2655	1390	2885	1490	3145	1590	3305	1590	3305	1590	3305	1590	3305
		8000	1325	2765	1425	3015	1530	3300	1635	3615	1745	3930	1745	3930	1745	3930	1745	3930	

Figure 5-4. Takeoff Distance (Sheet 1 of 2)

TAKEOFF DISTANCE
2700 LBS AND 2400 LBS
[SHORT FIELD]

REFER TO SHEET 1 FOR APPROPRIATE CONDITIONS AND NOTES.

WEIGHT LBS	TAKEOFF SPEED KIAS		PRESS ALT FT	0°C		10°C		20°C		30°C		40°C	
	LIFT OFF	AT 50 FT		GRND ROLL	TOTAL TO CLEAR 50 FT OBS	GRND ROLL	TOTAL TO CLEAR 50 FT OBS	GRND ROLL	TOTAL TO CLEAR 50 FT OBS	GRND ROLL	TOTAL TO CLEAR 50 FT OBS	GRND ROLL	TOTAL TO CLEAR 50 FT OBS
2700	47	55	S.L.	520	1000	555	1065	595	1135	635	1210	680	1285
			1000	565	1085	605	1160	650	1235	695	1320	740	1405
			2000	615	1185	660	1265	710	1355	760	1445	810	1540
			3000	675	1295	725	1385	775	1485	830	1585	885	1695
			4000	735	1425	790	1525	850	1630	910	1745	970	1870
			5000	805	1565	865	1680	930	1800	995	1930	1065	2075
			6000	885	1730	950	1860	1020	1995	1095	2150	1170	2310
			7000	970	1920	1045	2065	1120	2225	1205	2400	1290	2595
			8000	1070	2140	1150	2310	1235	2500	1325	2705	1420	2935
			2400	44	52	S.L.	395	775	425	825	455	875	485
1000	430	840				465	895	495	950	530	1010	565	1075
2000	470	915				505	975	540	1035	575	1105	615	1175
3000	515	995				550	1060	590	1130	630	1205	675	1285
4000	560	1085				600	1160	645	1235	690	1320	735	1405
5000	615	1185				655	1270	705	1355	755	1445	805	1545
6000	670	1300				720	1395	770	1490	825	1595	885	1705
7000	735	1435				790	1535	845	1645	905	1765	970	1890
8000	810	1585				870	1700	930	1825	1000	1960	1070	2105

Figure 5-4. Takeoff Distance (Sheet 2 of 2)

MAXIMUM RATE OF CLIMB

CONDITIONS:

Flaps Up
2400 RPM
Full Throttle
Cowl Flaps Open

NOTE:

Mixture leaned above 5000 feet for smooth engine operation and increased power.

WEIGHT LBS	PRESS ALT FT	CLIMB SPEED KIAS	RATE OF CLIMB - FPM			
			-20°C	0°C	20°C	40°C
2950	S.L.	78	1155	1070	990	910
	2000	76	1020	945	865	790
	4000	75	890	815	740	670
	6000	74	760	690	620	550
	8000	73	635	565	500	430
	10,000	72	510	440	375	---
	12,000	71	385	320	255	---
	14,000	70	260	195	---	---
	16,000	68	140	75	---	---

Figure 5-5. Maximum Rate of Climb

TIME, FUEL, AND DISTANCE TO CLIMB

MAXIMUM RATE OF CLIMB

CONDITIONS:

Flaps Up
2400 RPM
Full Throttle
Cowl Flaps Open
Standard Temperature

NOTES:

1. Add 1.7 gallons of fuel for engine start, taxi and takeoff allowance.
2. Mixture leaned above 5000 feet for smooth engine operation and increased power.
3. Increase time, fuel and distance by 10% for each 10°C above standard temperature.
4. Distances shown are based on zero wind.

WEIGHT LBS	PRESSURE ALTITUDE FT	TEMP °C	CLIMB SPEED KIAS	RATE OF CLIMB FPM	FROM SEA LEVEL		
					TIME MIN	FUEL USED GALLONS	DISTANCE NM
2950	S.L.	15	78	1010	0	0	0
	2000	11	76	900	2	0.7	3
	4000	7	75	790	5	1.5	6
	6000	3	74	680	7	2.3	10
	8000	- 1	73	570	11	3.2	14
	10,000	- 5	72	460	15	4.3	20
	12,000	- 9	71	350	20	5.6	27
	14,000	- 13	70	240	27	7.3	37
	16,000	- 17	68	130	39	10.0	55

Figure 5-6. Time, Fuel, and Distance to Climb (Sheet 1 of 2)

TIME, FUEL, AND DISTANCE TO CLIMB

NORMAL CLIMB - 90 KIAS

CONDITIONS:

Flaps Up
2400 RPM
23 Inches Hg or Full Throttle
Cowl Flaps Open
Standard Temperature

NOTES:

1. Add 1.7 gallons of fuel for engine start, taxi and takeoff allowance.
2. Mixture leaned above 5000 feet for smooth engine operation and increased power.
3. Increase time, fuel and distance by 10% for each 10°C above standard temperature.
4. Distances shown are based on zero wind.

WEIGHT LBS	PRESSURE ALTITUDE FT	TEMP °C	RATE OF CLIMB FPM	FROM SEA LEVEL		
				TIME MIN	FUEL USED GALLONS	DISTANCE NM
2950	S.L.	15	670	0	0	0
	2000	11	670	3	0.8	5
	4000	7	670	6	1.7	9
	6000	3	640	9	2.6	14
	8000	- 1	510	13	3.6	20
	10,000	- 5	385	17	4.8	28

Figure 5-6. Time, Fuel, and Distance to Climb (Sheet 2 of 2)

CRUISE PERFORMANCE

PRESSURE ALTITUDE 2000 FEET

CONDITIONS:
2950 Pounds
Recommended Lean Mixture
Cowl Flaps Closed

NOTE

For best fuel economy at 65% power or less, operate at the leanest mixture that results in smooth engine operation or at peak EGT if an EGT indicator is installed.

		20°C BELOW STANDARD TEMP -9°C			STANDARD TEMPERATURE 11°C			20°C ABOVE STANDARD TEMP 31°C		
RPM	MP	% BHP	KTAS	GPH	% BHP	KTAS	GPH	% BHP	KTAS	GPH
2400	22	77	134	13.1	74	135	12.6	71	136	12.2
	21	72	131	12.3	69	132	11.8	67	133	11.4
	20	67	128	11.5	65	128	11.1	63	129	10.7
	19	62	124	10.7	60	124	10.3	58	125	10.0
2300	23	78	135	13.3	75	136	12.8	72	137	12.4
	22	73	132	12.5	70	133	12.0	68	133	11.6
	21	68	128	11.7	66	129	11.3	64	130	10.9
	20	64	125	10.9	62	125	10.5	60	126	10.2
2200	23	73	132	12.5	70	133	12.0	68	133	11.6
	22	69	129	11.7	66	129	11.3	64	130	10.9
	21	64	125	11.0	62	126	10.6	60	126	10.2
	20	60	121	10.2	58	122	9.9	56	122	9.6
2100	23	68	128	11.6	66	129	11.2	64	130	10.8
	22	64	125	10.9	62	126	10.5	60	126	10.2
	21	60	121	10.2	58	122	9.9	56	122	9.6
	20	56	118	9.6	54	118	9.3	52	118	9.0
	19	52	113	9.0	50	114	8.7	48	113	8.5
	18	47	109	8.4	46	109	8.1	44	108	7.9

Figure 5-7. Cruise Performance (Sheet 1 of 8)

CRUISE PERFORMANCE
PRESSURE ALTITUDE 4000 FEET

CONDITIONS:
2950 Pounds
Recommended Lean Mixture
Cowl Flaps Closed

NOTE
For best fuel economy at 65% power or less, operate at the leanest mixture that results in smooth engine operation or at peak EGT if an EGT indicator is installed.

		20°C BELOW STANDARD TEMP -13°C			STANDARD TEMPERATURE 7°C			20°C ABOVE STANDARD TEMP 27°C		
RPM	MP	% BHP	KTAS	GPH	% BHP	KTAS	GPH	% BHP	KTAS	GPH
2400	22	---	---	---	76	139	13.0	73	140	12.5
	21	74	135	12.6	71	136	12.1	69	136	11.7
	20	69	131	11.8	66	132	11.3	64	133	11.0
	19	64	127	10.9	62	128	10.6	60	128	10.2
2300	23	---	---	---	76	140	13.1	74	141	12.8
	22	75	135	12.8	72	138	12.3	70	137	11.9
	21	70	132	12.0	68	133	11.5	65	134	11.2
	20	66	128	11.2	63	129	10.8	61	130	10.4
2200	23	75	135	12.8	72	138	12.3	70	137	11.9
	22	70	132	12.0	68	133	11.6	66	134	11.2
	21	66	129	11.3	64	129	10.9	61	130	10.5
	20	62	125	10.5	59	126	10.2	57	126	9.8
	19	57	121	9.8	55	121	9.5	53	121	9.2
2100	23	70	132	11.9	67	133	11.5	65	133	11.1
	22	66	128	11.2	63	129	10.8	61	130	10.4
	21	62	125	10.5	59	126	10.1	57	126	9.8
	20	57	121	9.8	55	121	9.5	53	122	9.3
	19	53	117	9.2	51	117	8.9	50	117	8.7
	18	49	112	8.6	47	112	8.3	46	112	8.1
	17	45	107	8.0	43	107	7.8	42	106	7.6

Figure 5-7. Cruise Performance (Sheet 2 of 8)

CRUISE PERFORMANCE

PRESSURE ALTITUDE 6000 FEET

CONDITIONS:
2950 Pounds
Recommended Lean Mixture
Cowl Flaps Closed

NOTE

For best fuel economy at 65% power or less, operate at the leanest mixture that results in smooth engine operation or at peak EGT if an EGT indicator is installed.

		20°C BELOW STANDARD TEMP -17°C			STANDARD TEMPERATURE 3°C			20°C ABOVE STANDARD TEMP 23°C		
RPM	MP	% BHP	KTAS	GPH	% BHP	KTAS	GPH	% BHP	KTAS	GPH
2400	22	---	---	---	77	143	13.3	75	144	12.8
	21	75	138	12.9	73	139	12.4	70	140	12.0
	20	71	135	12.1	68	136	11.6	66	136	11.2
	19	66	131	11.2	64	132	10.8	61	132	10.5
2300	22	77	139	13.1	74	140	12.6	71	141	12.2
	21	72	136	12.3	69	137	11.8	67	137	11.4
	20	67	132	11.5	65	133	11.1	63	133	10.7
	19	63	128	10.7	60	129	10.3	58	129	10.0
2200	22	72	136	12.3	69	137	11.9	67	137	11.5
	21	68	132	11.6	65	133	11.1	63	134	10.8
	20	63	129	10.8	61	129	10.4	59	130	10.1
	19	59	125	10.1	57	125	9.7	55	125	9.5
2100	22	67	132	11.5	65	133	11.1	63	133	10.7
	21	63	129	10.8	61	129	10.4	59	129	10.1
	19	55	121	9.5	53	121	9.2	51	121	8.9
	18	51	116	8.8	49	116	8.6	47	115	8.3
	17	47	111	8.2	45	110	8.0	43	109	7.8

Figure 5-7. Cruise Performance (Sheet 3 of 8)

CRUISE PERFORMANCE
PRESSURE ALTITUDE 8000 FEET

CONDITIONS:
2950 Pounds
Recommended Lean Mixture
Cowl Flaps Closed

NOTE
For best fuel economy at 65% power or less, operate at the leanest mixture that results in smooth engine operation or at peak EGT if an EGT indicator is installed.

		20°C BELOW STANDARD TEMP -21°C			STANDARD TEMPERATURE -1°C			20°C ABOVE STANDARD TEMP 19°C		
RPM	MP	% BHP	KTAS	GPH	% BHP	KTAS	GPH	% BHP	KTAS	GPH
2400	21	77	142	13.3	74	143	12.7	72	144	12.3
	20	72	139	12.4	70	139	11.9	67	140	11.5
	19	68	135	11.5	65	135	11.1	63	136	10.7
	18	63	130	10.7	60	131	10.3	58	131	10.0
2300	21	74	139	12.6	71	140	12.1	69	141	11.7
	20	69	136	11.8	66	137	11.3	64	137	11.0
	19	64	132	11.0	62	132	10.6	60	133	10.2
	18	60	127	10.2	58	128	9.9	56	128	9.6
2200	21	69	136	11.8	67	137	11.4	65	137	11.0
	20	65	132	11.1	63	133	10.7	60	133	10.3
	19	61	128	10.3	58	129	10.0	56	129	9.7
	18	56	124	9.7	54	124	9.3	52	124	9.1
2100	21	65	132	11.1	63	133	10.7	60	133	10.3
	20	61	129	10.4	59	129	10.0	57	129	9.7
	19	57	124	9.7	54	124	9.4	53	124	9.1
	18	52	120	9.1	50	120	8.8	49	119	8.5
	17	48	115	8.5	46	114	8.2	45	113	8.0

Figure 5-7. Cruise Performance (Sheet 4 of 8)

CRUISE PERFORMANCE

PRESSURE ALTITUDE 10,000 FEET

CONDITIONS:
2950 Pounds
Recommended Lean Mixture
Cowl Flaps Closed

NOTE

For best fuel economy at 65% power or less, operate at the leanest mixture that results in smooth engine operation or at peak EGT if an EGT indicator is installed.

		20°C BELOW STANDARD TEMP -25°C			STANDARD TEMPERATURE -5°C			20°C ABOVE STANDARD TEMP 15°C		
RPM	MP	% BHP	KTAS	GPH	% BHP	KTAS	GPH	% BHP	KTAS	GPH
2400	20	74	142	12.7	71	143	12.2	69	144	11.8
	19	69	138	11.8	67	139	11.4	64	140	11.0
	18	65	134	11.0	62	135	10.6	60	135	10.2
	17	60	129	10.2	57	130	9.8	55	130	9.5
2300	20	71	140	12.1	68	140	11.6	66	141	11.2
	19	66	136	11.3	64	136	10.9	61	136	10.5
	18	61	131	10.5	59	131	10.1	57	132	9.8
	17	57	126	9.7	55	126	9.4	53	126	9.1
2200	20	67	136	11.4	64	137	11.0	62	137	10.6
	19	62	132	10.6	60	132	10.2	58	133	9.9
	18	58	128	9.9	56	128	9.6	54	128	9.3
	17	53	123	9.2	51	123	8.9	50	122	8.7
2100	20	63	132	10.7	60	133	10.3	58	133	9.9
	19	58	128	10.0	56	128	9.6	54	128	9.4
	18	54	123	9.3	52	123	9.0	50	123	8.8
	17	50	118	8.7	48	118	8.4	46	116	8.2
	16	46	112	8.1	44	111	7.8	42	109	7.6

Figure 5-7. Cruise Performance (Sheet 5 of 8)

CRUISE PERFORMANCE
PRESSURE ALTITUDE 12,000 FEET

CONDITIONS:
2950 Pounds
Recommended Lean Mixture
Cowl Flaps Closed

NOTE

For best fuel economy, operate at the leanest mixture that results in smooth engine operation or at peak EGT if an EGT indicator is installed.

		20°C BELOW STANDARD TEMP -29°C			STANDARD TEMPERATURE -9°C			20°C ABOVE STANDARD TEMP 11°C		
RPM	MP	% BHP	KTAS	GPH	% BHP	KTAS	GPH	% BHP	KTAS	GPH
2400	18	66	138	11.3	64	139	10.9	61	139	10.5
	17	61	133	10.5	59	133	10.1	57	133	9.8
	16	56	128	9.7	54	128	9.4	52	127	9.1
	15	51	122	9.0	50	121	8.7	48	120	8.4
2300	18	63	135	10.8	61	135	10.4	59	135	10.0
	17	58	130	10.0	56	130	9.7	54	130	9.4
	16	54	125	9.3	52	125	9.0	50	124	8.7
	15	49	119	8.6	47	118	8.3	45	116	8.1
2200	18	59	131	10.2	57	131	9.8	55	131	9.5
	17	55	126	9.5	53	126	9.2	51	125	8.9
	16	51	121	8.8	49	120	8.5	47	119	8.3
	15	46	114	8.2	44	113	7.9	43	111	7.7
2100	18	56	127	9.6	54	127	9.3	52	126	9.0
	17	51	122	8.9	49	121	8.7	48	120	8.4
	16	47	116	8.3	45	115	8.1	44	113	7.8

Figure 5-7. Cruise Performance (Sheet 6 of 8)

CRUISE PERFORMANCE

PRESSURE ALTITUDE 14,000 FEET

CONDITIONS:
2950 Pounds
Recommended Lean Mixture
Cowl Flaps Closed

NOTE

For best fuel economy, operate at the leanest mixture that results in smooth engine operation or at peak EGT if an EGT indicator is installed.

		20°C BELOW STANDARD TEMP -33°C			STANDARD TEMPERATURE -13°C			20°C ABOVE STANDARD TEMP 7°C		
RPM	MP	% BHP	KTAS	GPH	% BHP	KTAS	GPH	% BHP	KTAS	GPH
2400	16	58	132	9.9	56	132	9.6	54	131	9.3
	15	53	126	9.2	51	125	8.9	49	124	8.6
	14	48	119	8.5	46	117	8.2	46	116	8.0
2300	16	55	129	9.5	53	129	9.2	51	127	8.9
	15	51	123	8.8	49	122	8.5	47	120	8.3
	14	46	115	8.1	44	113	7.9	42	111	7.7
2200	16	52	125	9.0	50	124	8.8	48	122	8.5
	15	48	118	8.4	46	116	8.1	44	115	7.9
2100	16	49	120	8.5	47	118	8.3	45	117	8.0

Figure 5-7. Cruise Performance (Sheet 7 of 8)

CRUISE PERFORMANCE
PRESSURE ALTITUDE 16,000 FEET

CONDITIONS:
2950 Pounds
Recommended Lean Mixture
Cowl Flaps Closed

NOTE

For best fuel economy, operate at the leanest mixture that results in smooth engine operation or at peak EGT if an EGT indicator is installed.

		20°C BELOW STANDARD TEMP -37°C			STANDARD TEMPERATURE -17°C			20°C ABOVE STANDARD TEMP 3°C		
RPM	MP	% BHP	KTAS	GPH	% BHP	KTAS	GPH	% BHP	KTAS	GPH
2400	15	55	130	9.4	53	129	9.1	51	128	8.8
	14	50	123	8.7	48	121	8.4	46	119	8.2
2300	15	52	127	9.1	50	126	8.8	48	124	8.5
	14	47	119	8.4	46	117	8.1	44	115	7.9
2200	15	49	122	8.6	47	120	8.3	46	118	8.1
2100	15	46	117	8.2	44	115	7.9	43	112	7.7

Figure 5-7. Cruise Performance (Sheet 8 of 8)

RANGE PROFILE 45 MINUTES RESERVE 65 GALLONS USABLE FUEL

CONDITIONS:
2950 Pounds
Recommended Lean Mixture for Cruise
Standard Temperature
Zero Wind

NOTE:
This chart allows for the fuel used for engine start, taxi, takeoff and climb, and the distance during a normal climb up to 10,000 feet and maximum climb above 10,000 feet.

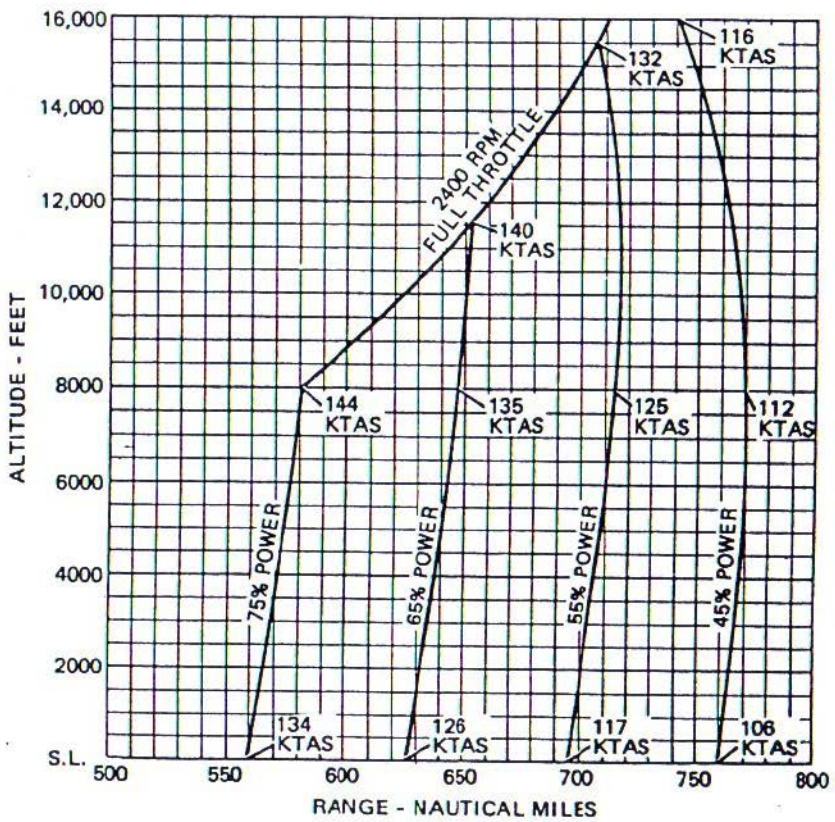

Figure 5-8. Range Profile (Sheet 1 of 2)

RANGE PROFILE

45 MINUTES RESERVE 88 GALLONS USABLE FUEL

CONDITIONS:

2950 Pounds
Recommended Lean Mixture for Cruise
Standard Temperature
Zero Wind

NOTE:

This chart allows for the fuel used for engine start, taxi, takeoff and climb, and the distance during a normal climb up to 10,000 feet and maximum climb above 10,000 feet.

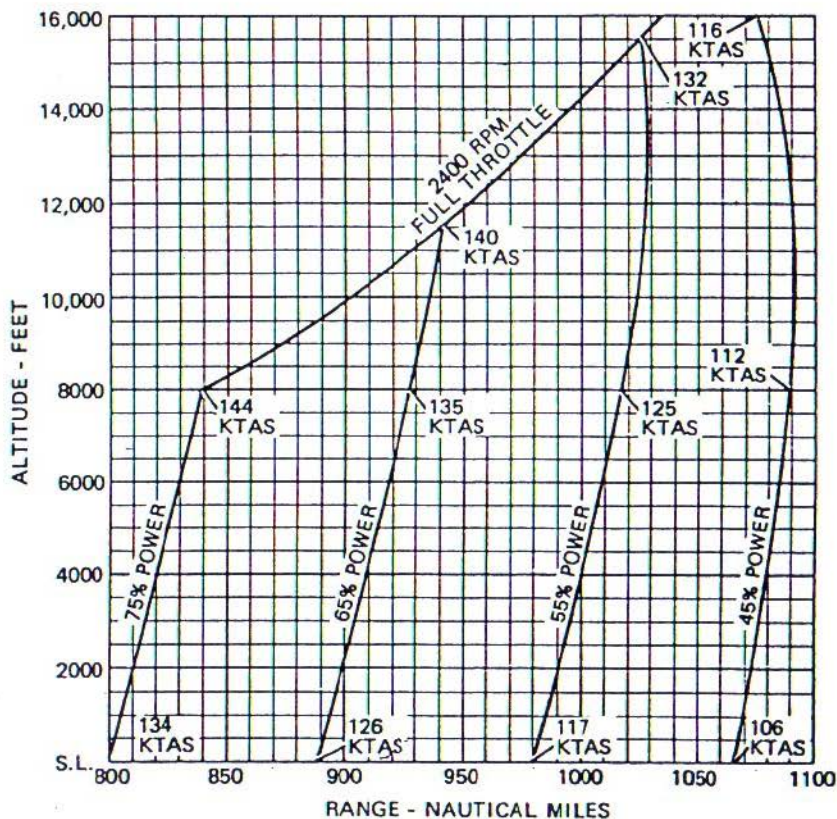

Figure 5-8. Range Profile (Sheet 2 of 2)

ENDURANCE PROFILE

45 MINUTES RESERVE
65 GALLONS USABLE FUEL

CONDITIONS:
2950 Pounds
Recommended Lean Mixture for Cruise
Standard Temperature

NOTE:
This chart allows for the fuel used for engine start, taxi, takeoff and climb, and the time during a normal climb up to 10,000 feet and maximum climb above 10,000 feet.

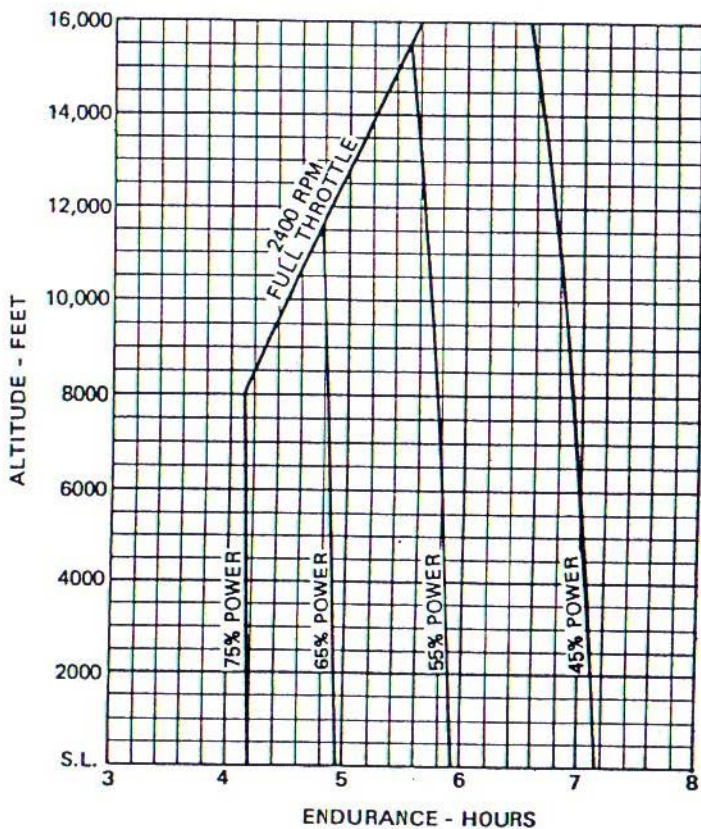

Figure 5-9. Endurance Profile (Sheet 1 of 2)

ENDURANCE PROFILE

45 MINUTES RESERVE
88 GALLONS USABLE FUEL

CONDITIONS:
2950 Pounds
Recommended Lean Mixture for Cruise
Standard Temperature

NOTE:
This chart allows for the fuel used for engine start, taxi, takeoff and climb, and the time during a normal climb up to 10,000 feet and maximum climb above 10,000 feet.

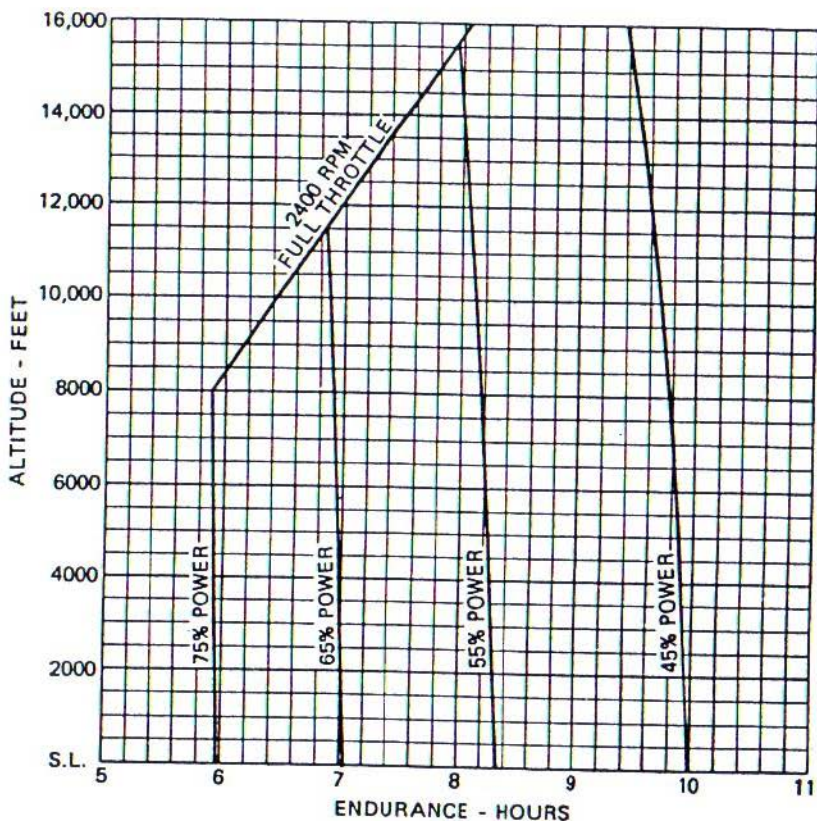

Figure 5-9. Endurance Profile (Sheet 2 of 2)

LANDING DISTANCE

SHORT FIELD

CONDITIONS:

- Flaps 40°
- Power Off
- Maximum Braking
- Paved, Level, Dry Runway
- Zero Wind

NOTES:

1. Short field technique as specified in Section 4.
2. Decrease distances 10% for each 9 knots headwind. For operation with tailwinds up to 10 knots, increase distances by 10% for each 2 knots.
3. For operation on a dry, grass runway, increase distances by 40% of the "ground roll" figure.

WEIGHT LBS	SPEED AT 50 FT KIAS	PRESS ALT FT	0°C		10°C		20°C		30°C		40°C	
			GRND ROLL	TOTAL TO CLEAR 50 FT OBS	GRND ROLL	TOTAL TO CLEAR 50 FT OBS	GRND ROLL	TOTAL TO CLEAR 50 FT OBS	GRND ROLL	TOTAL TO CLEAR 50 FT OBS	GRND ROLL	TOTAL TO CLEAR 50 FT OBS
2950	60	S.L.	560	1300	580	1335	600	1365	620	1400	640	1435
		1000	580	1335	600	1365	620	1400	645	1440	665	1475
		2000	600	1370	625	1405	645	1440	670	1480	690	1515
		3000	625	1410	645	1445	670	1485	695	1525	715	1560
		4000	650	1450	670	1485	695	1525	720	1565	740	1600
		5000	670	1485	695	1525	720	1565	745	1610	770	1650
		6000	700	1530	725	1575	750	1615	775	1660	800	1700
		8000	725	1575	750	1615	780	1665	805	1710	830	1750
		755	1625	780	1665	810	1715	835	1760	865	1805	

Figure 5-10. Landing Distance

SECTION 6

WEIGHT & BALANCE/ EQUIPMENT LIST

TABLE OF CONTENTS

	Page
Introduction	6-3
Airplane Weighing Procedures	6-3
Weight And Balance	6-6
Baggage and Cargo Tie-Down	6-6
Equipment List	6-15



INTRODUCTION

This section describes the procedure for establishing the basic empty weight and moment of the airplane. Sample forms are provided for reference. Procedures for calculating the weight and moment for various operations are also provided. A comprehensive list of all Cessna equipment available for this airplane is included at the back of this section.

It should be noted that specific information regarding the weight, arm, moment and installed equipment list for this airplane can only be found in the appropriate weight and balance records carried in the airplane.

It is the responsibility of the pilot to ensure that the airplane is loaded properly.

AIRPLANE WEIGHING PROCEDURES

1. Preparation:
 - a. Inflate tires to recommended operating pressures.
 - b. Remove the fuel tank sump quick-drain fittings and fuel selector valve drain plug to drain all fuel.
 - c. Remove oil sump drain plug to drain all oil.
 - d. Move sliding seats to the most forward position.
 - e. Raise flaps to the fully retracted position.
 - f. Place all control surfaces in neutral position.
2. Leveling:
 - a. Place scales under each wheel (minimum scale capacity, 1000 pounds).
 - b. Deflate nose tire and/or lower or raise the nose strut to properly center bubble on level (see figure 6-1).
3. Weighing:
 - a. With the airplane level and brakes released, record the weight shown on each scale. Deduct the tare, if any, from each reading.
4. Measuring:
 - a. Obtain measurement A by measuring horizontally (along the airplane center line) from a line stretched between the main wheel centers to a plumb bob dropped from the firewall.
 - b. Obtain measurement B by measuring horizontally and parallel to the airplane center line, from center of nose wheel axle, left side, to a plumb bob dropped from the line between the main wheel centers. Repeat on right side and average the measurements.
5. Using weights from item 3 and measurements from item 4, the airplane weight and C.G. can be determined.
6. Basic Empty Weight may be determined by completing figure 6-1.

SECTION 6
WEIGHT & BALANCE/
EQUIPMENT LIST

CESSNA
MODEL 182Q

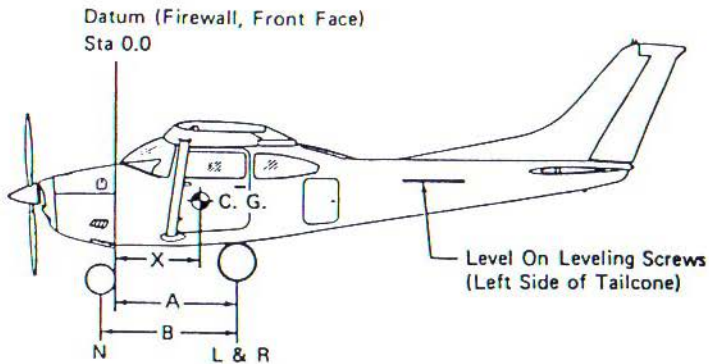

Scale Position	Scale Reading	Tare	Symbol	Net Weight
Left Wheel			L	
Right Wheel			R	
Nose Wheel			N	
Sum of Net Weights (As Weighed)			W	

$$X = \text{ARM} = \frac{(A) - (N) \times (B)}{W}; X = \left(\quad \right) - \left(\quad \right) \times \left(\quad \right) = \left(\quad \right) \text{ IN.}$$

Item	Weight (Lbs.)	X C.G. Arm (In.)	Moment/1000 (Lbs.-In.)
Airplane Weight (From Item 5, page 6-3)			
Add Oil:			
No Oil Filter (12 Qts at 7.5 Lbs/Gal)		-15.0	
With Oil Filter (13 Qts at 7.5 Lbs/Gal)		-15.0	
Add:			
Unusable Fuel (4 Gal at 6 Lbs/Gal)	24	48.0	1.2
Equipment Changes			
Airplane Basic Empty Weight			

Figure 6-1. Sample Airplane Weighing

WEIGHT AND BALANCE

The following information will enable you to operate your Cessna within the prescribed weight and center of gravity limitations. To figure weight and balance, use the Sample Problem, Loading Graph, and Center of Gravity Moment Envelope as follows:

Take the basic empty weight and moment from appropriate weight and balance records carried in your airplane, and enter them in the column titled YOUR AIRPLANE on the Sample Loading Problem.

NOTE

In addition to the basic empty weight and moment noted on these records, the C.G. arm (fuselage station) is also shown, but need not be used on the Sample Loading Problem. The moment which is shown must be divided by 1000 and this value used as the moment/1000 on the loading problem.

Use the Loading Graph to determine the moment/1000 for each additional item to be carried; then list these on the loading problem.

NOTE

Loading Graph information for the pilot, passengers, baggage/cargo and hatshelf is based on seats positioned for average occupants and baggage/cargo or hatshelf items loaded in the center of these areas as shown on the Loading Arrangements diagram. For loadings which may differ from these, the Sample Loading Problem lists fuselage stations for these items to indicate their forward and aft C.G. range limitation (seat travel and baggage/cargo or hatshelf area limitation). Additional moment calculations, based on the actual weight and C.G. arm (fuselage station) of the item being loaded, must be made if the position of the load is different from that shown on the Loading Graph.

Total the weights and moments/1000 and plot these values on the Center of Gravity Moment Envelope to determine whether the point falls within the envelope, and if the loading is acceptable.

BAGGAGE AND CARGO TIE-DOWN

A nylon baggage net having six tie-down straps is provided as standard equipment to secure baggage in the area aft of the rear seat and on the hatshelf. Six eyebolts serve as attaching points for the net. Two

eyebolts for the forward tie-down straps are mounted on the cabin floor near each sidewall just forward of the baggage door approximately at station 92; two center eyebolts mount on the floor slightly inboard of each sidewall just aft of the baggage door approximately at station 109; the two aft eyebolts secure at the top of the rear baggage wall at station 124. If a child's seat is installed, only the center and aft eyebolts will be needed for securing the net in the area remaining behind the seat. A placard on the baggage door defines the weight limitations in the baggage areas.

Cargo tie-down blocks and latch assemblies are available from any Cessna Dealer if it is desired to remove the rear seat (and child's seat, if installed) and utilize the rear cabin area to haul cargo. Two tie-down blocks may be clamped to the aft end of the two outboard front seat rails and are locked in place by a bolt which must be tightened to a minimum of fifty inch pounds. Seven tie-down latches may be bolted to standard attach points in the cabin floor, including three rear seat mounting points. The seven attach points are located as follows: two are located slightly inboard and just aft of the rear doorposts approximately at station 69; two utilize the aft outboard mounting points of the rear seat; one utilizes the rearmost mounting point of the aft center attach point for the rear seat approximately at station 84 (a second mounting point is located just forward of this point but is not used); and two are located just forward of the center baggage net tie-down eyebolts approximately at station 108. The maximum allowable floor loading of the rear cabin area is 200 pounds/square foot; however, when items with small or sharp support areas are carried, the installation of a 1/4" plywood floor is recommended to protect the airplane structure. The maximum rated load weight capacity for each of the seven tie-downs is 140 pounds and for the two seat rail tie-downs is 100 pounds. Rope, strap, or cable used for tie-down should be rated at a minimum of ten times the load weight capacity of the tie-down fittings used. Weight and balance calculations for cargo in the area of the rear seat, baggage and hatshelf area can be figured on the Loading Graph using the lines labeled 2nd Row Passengers or Cargo and/or Baggage or Passengers on Child's Seat.

LOADING ARRANGEMENTS

*Pilot or passenger center of gravity on adjustable seats positioned for average occupant. Numbers in parentheses indicate forward and aft limits of occupant center of gravity range.

**Arms measured to the center of the areas shown.

- NOTES
1. The usable fuel C.G. arm is located at station 46.5.
 2. The aft baggage wall (approximate station 124) can be used as a convenient interior reference point for determining the location of baggage area fuselage stations.

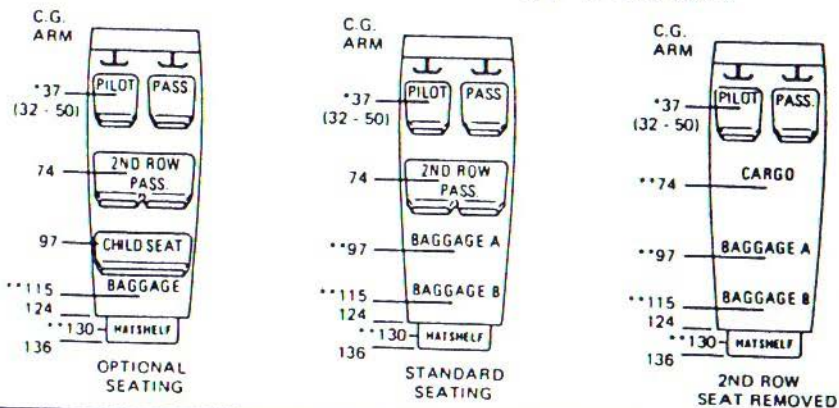
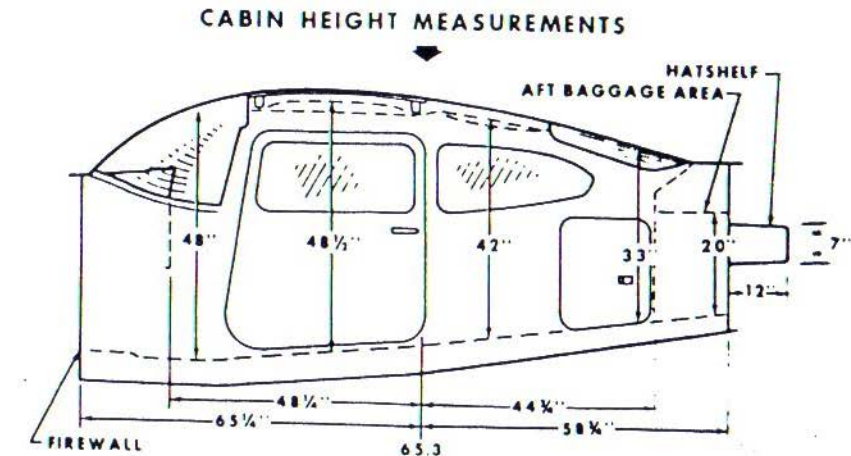

Figure 6-3. Loading Arrangements



DOOR OPENING DIMENSIONS

	WIDTH (TOP)	WIDTH (BOTTOM)	HEIGHT (FRONT)	HEIGHT (REAR)
CABIN DOOR	32"	36 1/2"	41"	38 1/2"
BAGGAGE DOOR	15 1/2"	15 1/2"	22"	20 1/2"

— WIDTH —
 ● LWR WINDC ●
 LINE
 * CABIN FLOOR

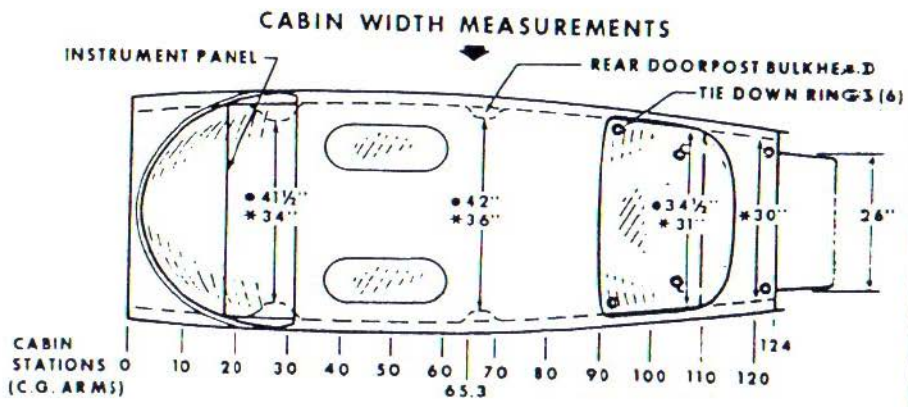

Figure 8-4. Internal Cabin Dimensions

SECTION 6
WEIGHT & BALANCE/
EQUIPMENT LIST

CESSNA
MODEL 182Q

SAMPLE AIRPLANE	YOUR AIRPLANE	
	Weight (lbs.)	Moment (lb.-ins. /1000)
<p>SAMPLE LOADING PROBLEM</p> <p>1. Basic Empty Weight (Use the data pertaining to your airplane as it is presently equipped. Includes unusable fuel and full oil)</p> <p>2. Usable Fuel (At 6 Lbs./Gal.) Standard Tanks (88 Gal. Maximum)</p> <p>3. Pilot and Front Passenger (Station 32 to 50)</p> <p>4. Second Row Passengers</p> <p>5. Cargo Replacing Second Row Seats (Sta. 65 to 82) Baggage (Area "A") or Passenger on Child's Seat (Sta. 82 to 108) 120 Lbs. Maximum</p> <p>6. Baggage-Aft (Area "B") and Hatshelf (Sta. 108 to 136) 80 Lbs. Maximum</p> <p>7. RAMP WEIGHT AND MOMENT</p> <p>8. Fuel allowance for engine start, taxi and runway</p> <p>9. TAKEOFF WEIGHT AND MOMENT (Subtract step 8 from step 7)</p> <p>10. Locate this point (2950 at 127.4) on the Center of Gravity Moment Envelope, and since this point falls within the envelope, the loading is acceptable.</p>	1800	63.3
	390	18.1
	340	12.6
	340	25.2
	90	8.7
	2960	127.9
	-10	-.5
	2950	127.4

Figure 6-5. Sample Loading Problem

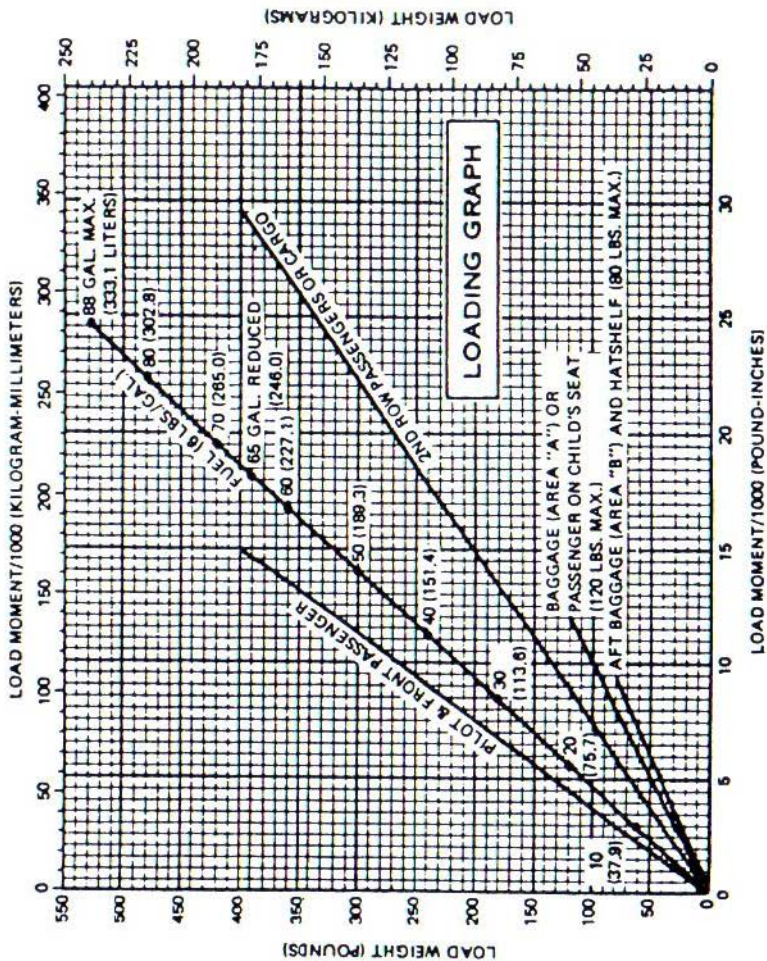

- NOTES: 1. Line representing adjustable seats above pilot and front seat passenger center of gravity on adjustable seats (additional for all average occupant). Refer to the Loading Arrangements Diagram for forward and aft limits of occupant C.G. range.
2. Hatshelf Maximum Load 25 Lbs.

Figure 6 Loading Graph

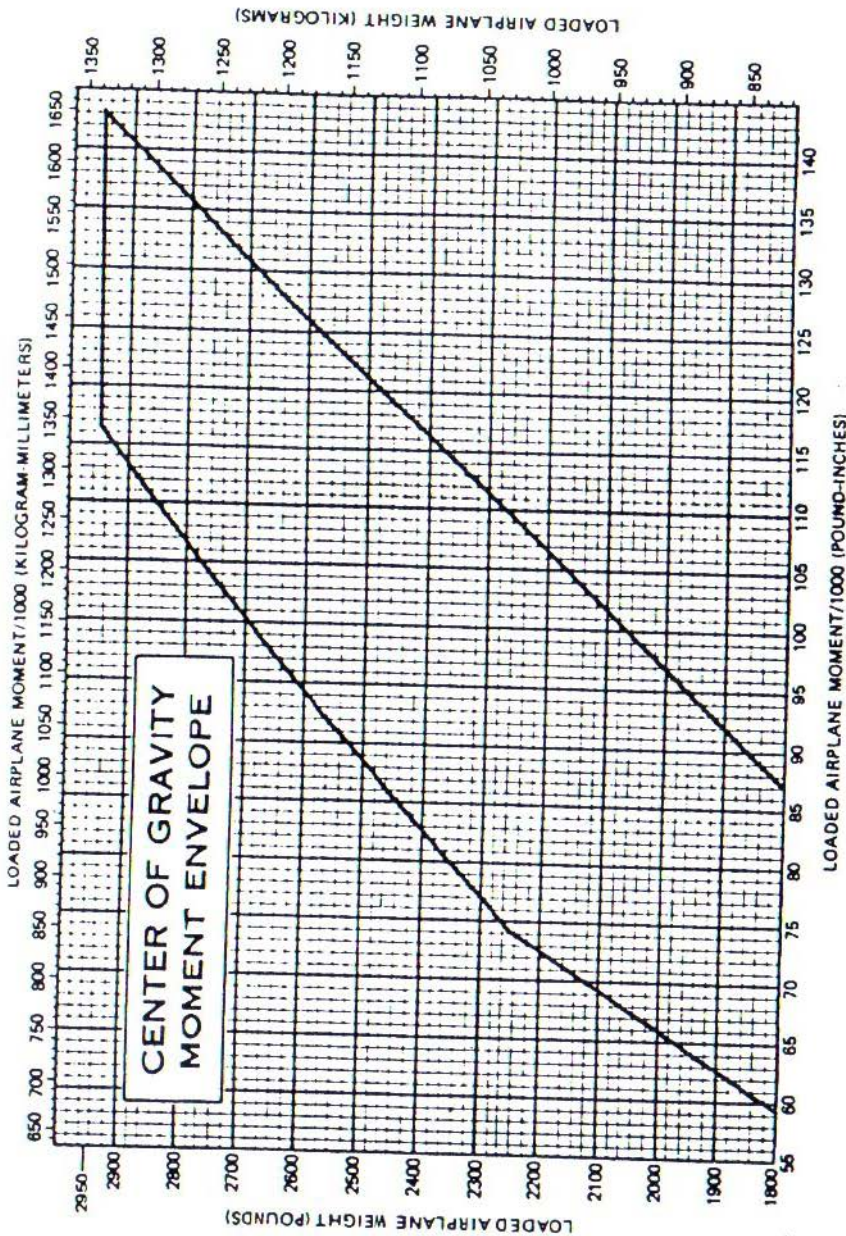

Figure 6-7. Center of Gravity Moment Envelope

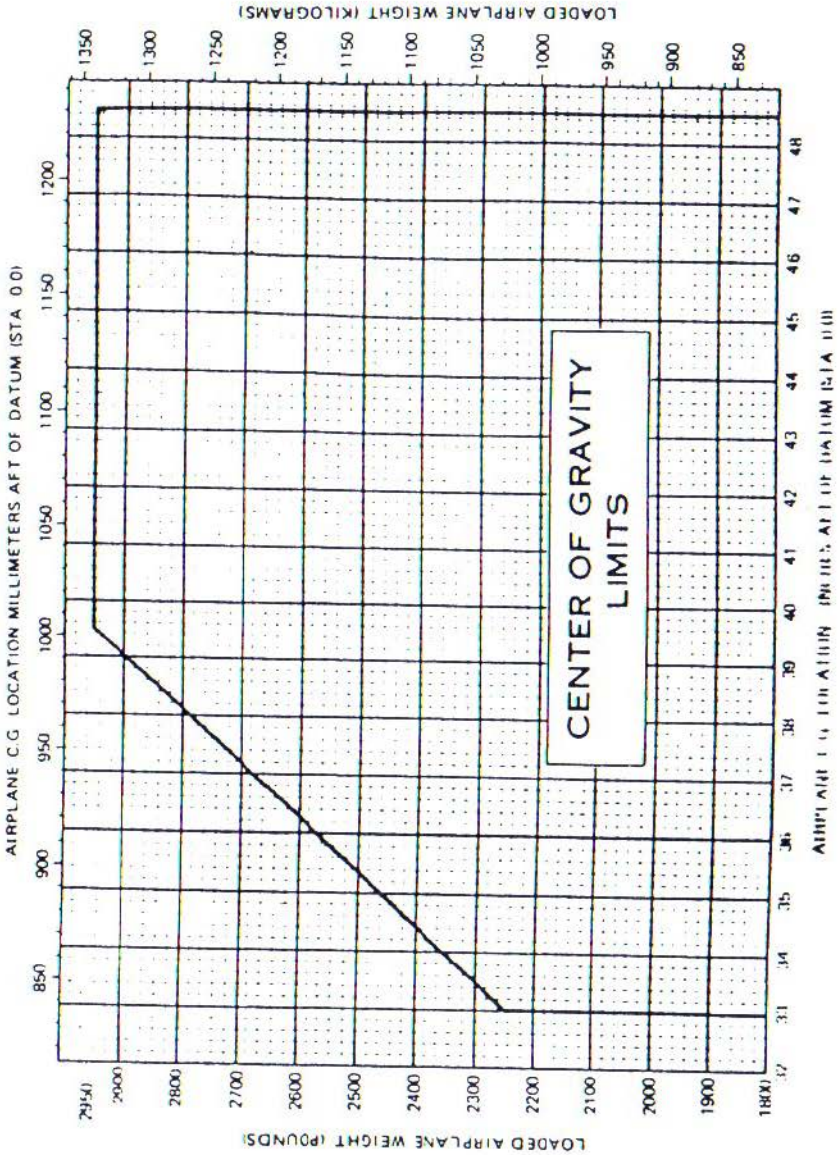

Figure 6 B Center of Gravity Limits

EQUIPMENT LIST

The following equipment list is a comprehensive list of all Cessna equipment available for this airplane. A separate equipment list of items installed in your specific airplane is provided in your aircraft file. The following list and the specific list for your airplane have a similar order of listing.

This equipment list provides the following information:

An **item number** gives the identification number for the item. Each number is prefixed with a letter which identifies the **descriptive** grouping (example: A. Powerplant & Accessories) under which it is listed. Suffix letters identify the equipment as a required item, a standard item or an optional item. Suffix letters are as follows:

- R = required items of equipment for FAA certification
- S = standard equipment items
- O = optional equipment items replacing required or standard items
- A = optional equipment items which are in addition to required or standard items

A **reference drawing** column provides the drawing number for the item.

NOTE

If additional equipment is to be installed, it must be done in accordance with the reference drawing, accessory kit instructions, or a separate FAA approval.

Columns showing **weight (in pounds)** and **arm (in inches)** provide the weight and center of gravity location for the equipment.

NOTE

Unless otherwise indicated, true values (not net change values) for the weight and arm are shown. Positive arms are distances aft of the airplane datum; negative arms are distances forward of the datum.

NOTE

Asterisks (*) after the item weight and arm indicate complete assembly installations. Some major components of the assembly are listed on the lines immediately following. The summation of these major components does not necessarily equal the complete assembly installation.

SECTION 8
WEIGHT & BALANCE/
EQUIPMENT LIST

CESSNA
MODEL 182Q

ITEM NO	EQUIPMENT LIST DESCRIPTION	REF DRAWING	WT LBS	ARM INS
	A. POWERPLANT & ACCESSORIES			
A01-R	ENGINE, CONTINENTAL O-470-U SPEC 5 TAC MAGNETOS WITH IMPULSE COUPLING CITL COOLER-HARRISON TWELVE 18MM X 3/4 20-3A SPARK PLUGS STARTER, 24 VOLT PRELUBRICATED CARBURETOR, MARVEL SCHEBLER FILTER, CARBURETOR AIR ALTERNATOR, 28 VOLT, 60 AMP OIL COOLER, NON-CONGEAL PCORINE 1E-1605-D CHANGES OIL COOLER CN THEM A01-R AND SPEC. & (NET CHANGE) OIL REPLACES OIL COOLER DESIGNATION TO O-470-U CHANGES (NET CHANGE)	0750201 SLICK-6214 TCM 627392 SCH 200A TC1 635994 M4-4-5 O15J038-4 C611503-0102 0750201	443.0* 10.3 2.6 17.8 5.8 10.8 11.5	-16.5* -31.0 -19.5 -4.5 -33.0 -31.5
A21-A	FILTER INSTALLATION, FULL FLOW ENGINE OIL ACAPTOR ASSEMBLY FILTER ASSEMBLY (SPIN CN TYPE)	1256025-2 1250922-2	3.3* 1.5	-3.5* -4.2
A33-R	PROPELLER, MCCAULEY C2A34C204/900C8-8	C161009-0106	50.8	-41.6
A37-R	GOVERNOR, PROPELLER (MCCAULEY C290-03/T14)	C161031-0107	3.0*	-32.0*
A41-R	SPINNER INSTALLATION, PROPELLER SPINNER DCME	0752637-11 1250412-3	1.7 0.2	-44.2 -46.5
A41-S	FORWARD SPINNER SUPPORT AFT SPINNER BULKHEAD ENGINE DRIVEN VACUUM PUMP	0752637-1 0706003-1	3.1* 1.1*	-37.8 -1.4*
A70-A	PRIMING SYSTEM, SIX CYLINDER	C471003-0102	1.8	-3.1
A73-A	OIL QUICK DRAIN VALVE (NET CHANGE)	0750125 1701015-4	1.0 NEGL	-15.0 -
	P. LANDING GEAR & ACCESSORIES			
R01-R-1	WHEEL, BRAKE & TIRE ASSY, 6-00X6 MAIN (2) WHEEL ASSY, CLEVELAND 40-113 (EACH) BRAKE ASSY, CLEVELAND 30-75 (LEFT) BRAKE ASSY, CLEVELAND 30-75 (RIGHT) TIRE, 6-PLY RATED BLACKWALL (EACH) TUBE	1241156-138 C163001-0104 C163030-0113 C163030-0114	39.6* 7.4 1.9 8.4	58.6* 58.5 55.5 58.9
R01-R-2	WHEEL, BRAKE & TIRE ASSY, 6-00X6 MAIN (2) WHEEL ASSY, MCCAULEY C-3001B (EACH) BRAKE ASSY, MCCAULEY C-3001B (LEFT)	C262023-0102 0741625 C163006-0101 C163032-0111	39.6* 2.1 7.8 1.8	58.9* 58.6* 55.5

ITEM NO	EQUIPMENT LIST DESCRIPTION	REF DRAWING	WT LBS	ARM INS
R04-R-1	<p>BRAKE ASSY. MCCAULEY C-30018 (RIGHT) TIRE. 6-PLY RATED BLACKWALL (EACH) WHEEL TIRE ASSY. 5.00X5 NOSF WHEEL ASSY. CLEVELAND 40-77 TIRE. 6-PLY RATED BLACKWALL WHEEL TIRE ASSY. 5.00X5 NOSF WHEEL ASSY. MCCAULEY TIRE. 6-PLY RATED BLACKWALL</p>	<p>C1630332-0112 C262026-0102 1241156-104 1241156-12 C262023-0101 C1630180103 C163005-0201 C262023-0101 0741638 0543079 0541223 0741641 1441003-1</p>	<p>1.8 8.4 1.9 9.4* 2.8 5.2 1.4 10.4* 3.8 3.2 1.4* 18.4* 3.9 5.7 0.6 4.5</p>	<p>55 58.9 58.9 77.1* 77.1 77.1 77.1 77.1 77.1 45.9* 60.2 58.0 58.9 58.9</p>
R10-S	<p>FAIRING INSTALLATION; WHEEL (SET OF 3) NOSF WHEEL FAIRING WALK WHEEL FAIRING BRAKE DISC FAIRING AXLE. STANDARD DUTY MAIN GEAR (SET OF 2) AXLE. HEAVY DUTY MAIN GEAR (SET OF 2)</p>			
R16-R R16-0				
C. ELECTRICAL SYSTEMS				
C01-R C01-C C04-R	<p>BATTERY. 24 VOLT. STANDARD DUTY ALTERNATOR CONTROL UNIT, 28 VOLT WITH HIGH AND LOW VOLTAGE SENSING</p>	<p>C614002-0101 C614002-0102 C611005-0101</p>	<p>23.2 25.2 0.4</p>	<p>130.0 130.0 -0.3</p>
C07-A C10-A	<p>GROUND SERVICE PLUG RECEPTACLE ELECTRIC ELEVATOR TRIM INSTL ELECTRIC DRIVE ASSEMBLY HEATING SYSTEM, PILOT & STALL WARNING SWITCH</p>	<p>0721019-2 2270307-2 0770724-2</p>	<p>3.2 3.8* 3.3 0.5</p>	<p>-2.6 217.7* 221.0 226.5</p>
C22-A C23-A C25-A	<p>LIGHTS. INSTRUMENT POST PANEL LIGHTS. ELECTRO-LUMINESCENT INSTL. MAP LIGHT. CONTROL WHEEL MOUNTED (CHANGES CONTROL WHEELS. E89-0. FRM 1260243-2 TO 1260243-9).</p>	<p>Z201003-2 0770419 1260243-9</p>	<p>0.5 2.1 0.1</p>	<p>17.5 16.5 27.0</p>
C31-A C40-A C43-A	<p>LIGHTS. COURTESY (NET CHANGE) DEFLECTOR. NAVIGATION LIGHT (SET OF 2) UMN LIGHT ASSEMBLY (IN FIN TIP) LIGHT ASSEMBLY (IN FIN TIP) FLASHER ASSY (IN FIN TIP) HEATING RESISTOR</p>	<p>0700615-11 0701013 0701042-2 C621901-0102 OR 95-6</p>	<p>0.5 MEGL 1.8* 0.7 0.0 0.2</p>	<p>61.7 208.6* 253.0 212.0</p>

SECTION 8
WEIGHT & BALANCE/
EQUIPMENT LIST

CESSNA
MODEL 182Q

ITEM NO	EQUIPMENT LIST DESCRIPTION	REF DRAWING	WT LBS	ARM INS
C46-A	STROBE LIGHTS, WHITE (EACH WING TIP) PCMFR SUPPLY (AERC) FLASH 152-0009) LIGHT ASSY. (AERC) FLASH 73-145)(2)	2201008-1 C622008-0102 0750417 4551	2.6* 2.3 0.3 1.0*	44.4* 46.7 42.0 -25.3*
C49-S	LIGHT INSTL. COMB. MOUNTED LANDING & TAXI LIGHT BULBS (SET OF 2)		1.6*	-22.5
D01-R	D. INSTRUMENTS			
D01-R	INDICATOR: AIRSPEED	C661064-0212	0.6	16.0
D04-A	INDICATOR: TRUE AIRSPEED (NET CHANGE)	1201108-7	0.2	16.5
D07-R	STATIC ALTERNATE AIR SOURCE	0701028-1	0.3	14.4
D07-R-1	ALTIMETER: SENSITIVE (FEET & MILLIBARS)	C661071-0101	0.7	15.3
D07-C-2	ALTIMETER: SENSITIVE (20 FT. MARKINGS)	C661071-0102	0.7	15.3
D10-A	ALTIMETER: INSTALLATION (2ND UNIT)	C661025-0102	0.8	16.0
D16-A-1	ENCODING ALTIMETER (REQUIRES RELOCATING STANDAR CARD TYPE ALTIMETER)	1213681	0.8	16.0
D16-A-2	ENCODING ALTIMETER: FEET AND MILLIBARS (REQUIRES RELOCATING STANDAR CARD TYPE ALTIMETER)	1213732	3.0	14.0
D16-A-3	ALTITUDE ENCODER, BLIND (INSTRUMENT PANEL INSTALLATION NOT REQUIRED)	0701099-1	1.5*	13.6*
D22-A	GAGE, CARBURETOR AIR TEMPERATURE	0750610-2	1.2	16.0
D25-S	CLOCK, ELECTRIC DIAL READ	C664508-0102	0.4	16.6
D28-R	CLOCK, ELECTRIC DIGITAL READ	C664511-0101	0.4	16.6
D34-R	COMPASS, MAGNETIC & MCOUNT	1213679-3	1.3	20.5
D49-A	INSTRUMENT CLUSTER, ENGINE & FUEL INDICATOR, INSTALLATION, ECONOMY MIXTURE FGT INDICATOR	C669545-0103 0750609-2	1.7*	16.5
D64-S	TERMOCOUPLE PRGR GYRO SYSTEM LEAD WIRE (IC)	C668201-0211 C668501-0204 C668501-0206	0.4 0.1 0.1	8.2* 17.1 -20.5
D64-S	DIRT FUNCTIONAL INDICATOR ATTITUDE INDICATOR	0701030-2 C661075-0101 C661076-0102	6.4* 2.9 2.2	13.7* 14.0 14.0
D64-S	HCSSES, FITTINGS, SCREWS, CLAMPS ETC. (ALTERNATE C661075 & C661076 GYRO'S MAY BE USED)		1.5	11.5
D64-0	GYRO SYSTEM INSTL. FOR NAV-C-MATIC 300A AUTOPILLOT (ITEM H31-A-2) ATTITUDE INDICATOR	0701038-1 C661076-0102	6.7* 2.2	13.4* 14.0

ITEM NO	EQUIPMENT LIST DESCRIPTION	REF DRAWING	WT LBS	ARM INS
D47-A	DIRECTIONAL INDICATOR (ALTERNATE C661076 ATTITUDE GYRO MAY BE USED) HOURMETER, INSTALLATION RECORDING INDICATOR CII PRESSURE SWITCH GAGE, MANIFOLD PRESSURE GAGE, OUTSIDE AIR TEMPERATURE TACHOMETER INSTALLATION, ENGINE RECORDING TACH INDICATOR REGULATOR, TURN COORDINATOR (28 VOLT ONLY) INDICATOR, TURN COORDINATOR (10/30 VOLT) INDICATOR, TURN COORDINATOR (FCR NOM'S) INDICATOR, TURN & BANK INDICATOR, VERTICAL SPEED	40760-0104 1200744 C664503-0101 S1711-1 C662035-0101 C668507-0101 0706006 C668C20-0117 C661003-0505 C661003-0506 42320-0028 S-1303N2 C661080-0101	3.2 0.5* 0.2 0.9 0.1* 0.9* 0.7 1.3 1.3 1.3 1.0	13.4 7.6* 17.5 15.8 15.8 12.8* 16.9 16.0 16.0 15.5 15.4
F. CABIN ACCOMMODATIONS				
F05-R	SEAT, ADJUSTABLE FCRE & AFT - PILOT	0714042-1	13.0	44.0
F06-R	SEAT, ARTICULATING VERT. ADJ. - PILOT	0714042-1	124.0	44.0
F07-S	SEAT, ADJUSTABLE FORE & AFT - CO-PILOT	0714042-1	224.0	41.5
F09-S	SEAT, 2ND ROW BENCH	0714041-1	22.0	80.2*
F11-A	SEAT INSTALLATION, AUXILIARY (CHILDS)	0501009-5	8.9	104.4*
F15-R	SEAT ASSY, FOLD-AWAY (120 LB MAX CAP.)	0714039-4	6.9	101.1
F15-R	RELT ASSY, LAP (PILOT SEAT)	S1746-103	1.0	37.0
F19-C	SHOULDER HARNESS ASSY, PILOT	S2275-101	0.6	37.0
F19-C	PILOT & CO-PILOT INERTIA REEL INSTL. (NET CHANGE)	0701077	3.6	92.0
F23-S	RELT & SHOULDER HARNESS ASSY, CO-PILOT	S2275-3	1.6	37.0
F27-S	RELT ASSY, 2ND ROW OCCUPANTS (SET OF 2)	S-1746-1	13.2	74.5
F35-A-1	RELT & SHOULDER HARNESS ASSY, 2ND ROW	S-2275-7	02.0	67.0
F35-A-1	INTERIOR, VINYL SEAT COVERS (NET CHANGE)	CES-1134	02.0	67.0
F37-C	INTERIOR, LFATHR SEAT COVERS (NET CHANGE)	CES-1134	02.0	67.0
F39-A	OPENABLE RH CABIN DOOR W/ WINDC (NET CHANGE)	0701085-6	02.0	67.0
F43-A	WIRING, OVERHEAD CABIN TCP (NET CHANGE)	0701084-1	03.5	62.3
F43-S	VENTILATION SYSTEM, 2ND ROW SEATING	0701084-1	3.5	62.3
F45-S	CURTAIN, REAR WINDOW	0701091-12	3.5	62.3
F47-A	OXYGEN SYSTEM, 4 PORT	0701091-12	34.0	112.2*

SECTION 8
WEIGHT & BALANCE/
EQUIPMENT LIST

CESSNA
MODEL 182Q

ITEM NO	EQUIPMENT LIST DESCRIPTION	REF DRAWING	WT LBS	ARM INS
F49-A	OXYGEN CYLINDER-EMPTY	C166001-0601	25.0	128.3
F50-A	OXYGEN MASKS, PILOT & 3 PASSENGER		1.5	128.0
F51-A	CUP HOLDER, RETRACTABLE (SET OF 2)	C166005	0.1	155.0
F52-A	HEADREST, 1ST ROW (INSTALLED ARM) (EACH)	1201124	0.9	16.0
F53-A	HEADREST, 2ND ROW (INSTALLED ARM) (EACH)	12015073-1	0.9	17.0
F54-A	SUN VISORS (SET OF 2)	12015073-1	0.9	87.0
F55-A	SUN VISORS (SET OF 2)	0701024-1	1.0	27.0
F56-A	APPROACH PLATE, HCLDR NET	1511511	0.5	37.0
F57-A	RAGGAGE TIE DOWN NET	1215042-1	0.5	108.0
F58-A	CARGO TIE DOWN LATCHES & SEAT RAIL CLAMPS (USE INSTALLED CARGO ARM/STOWED) (NOT FACTORY INSTALLED)	0701029-1	1.2	
F59-A	DUAL CONTROLS			
F60-A	WHEEL, PEDALS & TOE BRAKES	0760101-5	6.7	14.1
F61-A	CONTROL WHEEL, PILOT ALL PURPOSE (NET CHG)	0760650-3	NEGL	-
F62-A	HEATING SYSTEM, CABIN & CARBURETOR AIR (INCLUDES EXHAUST SYSTEM)	1260243-9	18.0	-16.0
F63-A		0750201		
F64-A	F. PLACARDS, WARNINGS & MANUALS			
F65-A	PLACARD, OPERATIONAL LIMITATIONS-VFR DAY	05C5087-7	NEGL	-
F66-A	PLACARD, OPERATIONAL LIMITATIONS-VFR DAY-NIGHT	0505087-8	NEGL	-
F67-A	PLACARD, OPERATIONAL LIMITATIONS-IFR DAY-NIGHT	0505087-9	NEGL	-
F68-A	INDICATOR, STALL WARNING HORN-AUDIBLE	S-2077-8	1.0	17.5
F69-A	PILOTS, OPERATING HANDBOOK AND FAA APPROVED AIRPLANE FLIGHT MANUAL, STCWF	D1176-13PH	1.3	-
G01-A	G. AUXILIARY EQUIPMENT			
G02-A	TAILCONE LIFT HANDLES (SET OF 2)	2201009-1	1.9	186.5
G03-A	HOISTING RINGS, AIRPLANE (NCT FACTORY INSTALLED)	0700612-1	1.9	45.6
G04-A	STRUTS, PROOFING, INTERNAL	0760007-1	7.0	70.0
G05-A	STATIC DISCHARGERS (SET OF 1/)	1201131-2	0.4	130.5
G06-A	STABILIZER, PARASAIL PROTS	0500411-2	2.7	206.0
G07-A	TOWBAR, AIRCRAFT (STCWF ARM SHOWN)	0501019-1	1.6	57.0

ITEM NO	EQUIPMENT LIST DESCRIPTION	REF DRAWING	WT LBS	ARM INS
G25-S	PAINT, OVERALL EXTERIOR, MODIFIED POLY-URETHANE OVERALL WHITE BASE CULCRED STRIPE	0704042	12.7*	91.9*
G31-A	CABLES, CORROSION RESISTANT (NET CHANGE)	0760007-1	11.9	92.2
G55-A-1	FIRE EXTINGUISHER, HAND TYPE (FOR USE WITH STANDARD PILOT SEAT)	0731014-1	0.4	82.3
G55-A-2	FIRE EXTINGUISHER, HAND TYPE (FOR USE WITH VERTICAL ADJUSTING PILOT SEAT)	0701014-2	3.0	35.0
G61-A	WRITING TABLE	1715072-1	3.2	25.0
G67-A	PFADL EXTENSIONS, RUDDER, REMOVABLE - SET	0701048	3.6	61.5
G99-A	CF 2 (STICKABLE) - INSTALLED ARM SHOWN WINTERIZATION KIT, ENGINE WINTER FRONT INSTALLED ARM SHOWN	0752647-2	2.3	8.0
			1.1*	-29.5*
			0.5	-34.3
H01-A-1	H. AVIONICS & AUTOPILOTS CESSNA 300 ADF WITH RFO REC FIFER WITH RFO (R-546E) GCONTOMETER INDICATOR (IN-346A) ADF LOOP ANTENNA & ASSOC. WIRING ADF SENSE ANTENNA ACOUNTING BOX & MISC ITEMS CESSNA 400 ADF (W/8FO) ADF REC FIFER WITH RFO (R-446A) GCONTOMETER INDICATOR (IN-346A) ADF LOOP ANTENNA & ASSOC. WIRING ADF SENSE ANTENNA ACOUNTING BOX & MISC ITEMS AM/FM STEREO RECEIVER & CASSETTE PLAYER HEADSET (SET OF 2, 4 MAY BE USED) STEREO RECEIVER INSTALLATION ANTENNA WIRING & MISC ITEMS DME INSTALLATION, NARCO MCUNT ASSY TRANSCIEVER (OME 190) ANTENNA ANTENNA	41240-0001 41420-0001 40980-1001 3960104-1 0770750-608 3910160-1 43090-1028 40980-1001 3960104-1 0770750-608 C596532-0101 K/6LC 3930194 3910166-6 3312-406	8.5* 3.5 0.9 2.1 20.3 1.7 18.5* 3.5 0.9 2.1 0.3 1.7 15.4* 2.7 2.0 2.7 0.7 5.2* 0.6 0.2*	22.1* 16.0 133.4 56.2 17.0 12.2 13.0 19.0 3.2 36.2 96.2 17.0 37.0 15.0 79.4 14.3 11.0 18.4 101.9* 133.7 14.0
H01-A-2		3910167-16 44000 44020-1100	13.9*	101.9*
H03-A			1.6	14.0
H04-A-1				
H04-A-2				

SECTION 8
WEIGHT & BALANCE/
EQUIPMENT LIST

CESSNA
MODEL 182

ITEM NO	EQUIPMENT LIST DESCRIPTION	REF DRAWING	WT LBS	ARM INS
H05-A-1	ANTENNA DELETED. IN-385A (DOME) INDICATOR NET CHANGE) R-NAV COMPUTER (R-478A) INDICATOR ADDED. IN-442AR INDICATOR DELETED. IN-385A	4294J 3910168-18 44100-0000 43910-1000	0.2 4.7*	88.4 12.0*
H05-A-2	FOSTER R-NAV 511	3910203	-1.6*	12.5*
H07-A	COMPUTER-INDICATOR (INCLUDES VOR/ILS INDICATOR EXCHANGE FOR VOR/LOC) RECEIVER MOUNTED ON UPPER WINDSHIELD ANTENNA INDICATOR (IN-386A) (INDICATOR ACTUAL WT IS 1.7 LBS)	3910157 42100-0000 36450-0000 1270098-1 46860-2000	2.1 0.3 0.2 0.1	130.1 130.1 126.6 15.5
H08-A-1	AUTO-RADIAL CENTERING INDICATOR ARC/LCC EXCHANGE FOR VOR/LCC IN ITEMS H22-A AND H25-A (WT NET CHANGE) ARC/LOC INDICATOR ADDED	3910196	0.2*	15.5*
H08-A-2	VOR/LOC INDICATOR CELETED AUTO-RADIAL CENTERING INDICATOR ARC/ILS EXCHANGE FOR VOR/ILS INDICATOR IN ITEM H07-A ONLY	46860-1200 3910196	1.8 -0.1*	15.5 15.5*
H11-A-1	ARC/ILS INDICATOR (IN-386AC) ADDED VOR/ILS INDICATOR (IN-386A) DELETED PANTRONICS HF TRANSCEIVER 2ND UNIT PT10-A TRANSCEIVER (HIGH FREQUENCY PX-10R)-28 REMOVE POWER SUPPLY PX-10R)-28 REMOVE ANTENNA LOAD BOX ANTENNA INSTL 35.1 INCHES LONG	46860-2200 3910196 46860-2200 C582103-0101 C582103-0301 C589502-0201 3960117 3910158 99681 99683 99816	1.9 1.8* 1.8 3.8 8.6 0.23 2.5	5.5* 98.0* 110.7 130.0 152.1* 156.1* 156.1* 138.0 115.7
H11-A-2	SUNAIR 58B HF TRANSCEIVER 2ND UNIT RE-1000 SINGLE SIDE BAND XCVR (ASB-125) PATCIDA REMOTE POWER AMPLIFIER CU-110 ANTENNA COUPLER (LOAD BOX) ANTENNA INSTL 35.1 INCHES LONG	99681 99816 3960117 3910158	5.5 5.2 0.23*	138.0 115.7
H13-A	CESSNA 400 MARKER BEACCN RECEIVER (R-402A)	42410-5428 1270720-1	0.7 1.0*	117.4 132.5*
H16-A-1	CESSNA 300 TRANSPONDER RECEIVER-TRANSMITTER (RT-359A)	41420-0028 42940-0000	1.7 0.2*	132.5* 127.0*
H16-A-2	ANTENNA CESSNA 400 TRANSPONDER	3910128-2	0.4	132.5*

ITEM NO	EQUIPMENT LIST DESCRIPTION	REF DRAWING	WT LBS	ARM INS
H77-A-1	RECEIVER-TRANSMITTER (RT-459A) ANTENNA 300 NAV/COM 72C CH CCM 1ST UNIT REQUIRES H34-A TO BE OPERATIONAL RECEIVER-INDICATOR (IN-385A) VOR/LOC INDICATOR (IN-385A) MOUNT, WIRING & MISC HARDWARE	41470-1028 42940-0000 3910183-16	20.8 8.3*	17.5 12.9*
H77-A-3	RECEIVER-TRANSMITTER (RT-459A) ANTENNA 400 NAV/COM WITH IN-385A (300 SERIES INDICATOR 1ST UNIT OPERATIONAL) REQUIRES H34-A TO BE OPERATIONAL VOR/LOC INDICATOR (IN-385A) MOUNT, WIRING & MISC HARDWARE	46660-1000 46860-1000 3910189-5	5.5 1.6 1.2 8.3*	12.5 11.8 11.9*
H75-A-1	RECEIVER-TRANSMITTER (RT-459A) ANTENNA 300 NAV/COM 720 CH CCM 2ND UNIT REQUIRES H37-A TO BE OPERATIONAL VOR/LOC INDICATOR (IN-385A) MOUNT, WIRING & MISC HARDWARE	47360-1000 46860-1000 3910183-15	5.5 1.6 8.3*	12.5 13.5 11.8*
H75-A-2	RECEIVER-TRANSMITTER (RT-459A) ANTENNA 400 NAV/COM 720 CH CCM WITH 300 SERIES INDICATOR, 2ND UNIT REQUIRES H37-A TO BE OPERATIONAL VOR/LOC INDICATOR (IN-385A) MOUNT, WIRING & MISC HARDWARE	46860-1000 46860-1000 3910189-6	5.5 1.2 1.2 8.3*	12.5 15.5 11.8 11.9*
H28-A-1	RECEIVER-TRANSMITTER (RT-485A) ANTENNA 300 NAV/COM 720 CH CCM 2ND UNIT REQUIRES H37-A TO BE OPERATIONAL VOR/LOC INDICATOR (IN-385A) MOUNT, WIRING & MISC HARDWARE	47360-1000 46860-1000	5.5 1.6	12.5 15.5
H28-A-2	RECEIVER-TRANSMITTER (RT-485A) ANTENNA 400 NAV/COM 720 CH CCM WITH 300 SERIES INDICATOR, 2ND UNIT REQUIRES H37-A TO BE OPERATIONAL VOR/LOC INDICATOR (IN-385A) MOUNT, WIRING & MISC HARDWARE	0470419 C589511-0117 C589511-0109 0470419	3.5 3.3 0.1 3.5*	134.6* 137.5 137.5 134.6*
H31-A-1	RECEIVER-TRANSMITTER (RT-485A) ANTENNA 300 NAV/COM 720 CH CCM 2ND UNIT REQUIRES H37-A TO BE OPERATIONAL VOR/LOC INDICATOR (IN-385A) MOUNT, WIRING & MISC HARDWARE	C589511-0113 C589511-0109 3910162-02 43610-102	3.3 9.1 1.1 10.0	134.5 137.8 15.0 15.0
H31-A-2	RECEIVER-TRANSMITTER (RT-485A) ANTENNA 400 NAV/COM 720 CH CCM WITH 300 SERIES INDICATOR, 2ND UNIT REQUIRES H37-A TO BE OPERATIONAL VOR/LOC INDICATOR (IN-385A) MOUNT, WIRING & MISC HARDWARE	0700215 3910163 42660-1202 0701038 07320-028 0700215	5.8 9.8 1.4 1.0 3.0 10.4*	78.6* 78.6* 17.0 17.0 78.9*

SECTION 8
WEIGHT & BALANCE/
EQUIPMENT LIST

CESSNA
MODEL 182Q

ITEM NO	EQUIPMENT LIST DESCRIPTION	REF DRAWING	WT LBS	ARM INS
H34-A	<p>CONTROLLER-AMPLIFIER NON-SLAVED HST. 1G-832C HST CONVERTER INSTALLATION CBA-0-1 TURN COORDINATOR (NET CHANGE) WING SERVO INSTALLATION STANDARD DIRECTIONAL INDICATOR DELETED VGR/TLS INDICATOR DELETED MISC ITEMS & HARDWARE BASIC AVIONICS KIT (REQUIRED BY AND AVAIL- ABLE WITH 1ST UNIT ONLY) CARTIN SPEAKER INSTL. RADIO COOLING AC/DC FILTER (ON ALTERNATOR) RECEIVER INSTALLATION KIT CARLE ASSY FOR CCM ANTENNA CMNT ANTENNA INSTALLATION AHDIC CONTROL PANEL AND CABIN TOP HEADSET INSTALLATION MICROPHONE INSTALLATION ANTENNA & COUPLER KIT (ROD & AVAILABLE WITH 2ND NAV/COM INSTL.) ANTENNA & CARLE, LF VHF CCM ADF ANTI PRECIP SENSE ANTENNA FLUSH MOUNTED COM ANTENNA (FLUSH MTD IN LEADING EDGE VERTICAL FIN MIC-HFADF COMBINATION, LIGHT WT REQUIRES FR9-C INSTALLATION, PADDED (STOWED) HFACSET-MICROPHONE, PADDED (STOWED) REQUIRES FB9-T INSTALLATION RECEIP TRANSPONDER IDENT SWITCH</p>	<p>42660-2202 44690-2000 42323-0028 0700215 C661075-0101 3910186-8 0770750-741 3930208 3940148-2 3930186 3950126-40 3950126-9 3960102-9 3960113-2 3970147 3970137-2 3970139-1 3910185 S-2212-1 3910154-64 3910154-63 C596530-0101 C596531-0101 3910205</p>	<p>1.4 4.5 1.1 130.5 0.8 78.6 12.0 12.0 78.6 54.4*</p>	<p>15.0 14.0 130.5 78.6 12.0 12.0 78.6 54.4*</p>
H37-A	<p>ANTENNA & COUPLER KIT (ROD & AVAILABLE WITH 2ND NAV/COM INSTL.) ANTENNA & CARLE, LF VHF CCM ADF ANTI PRECIP SENSE ANTENNA FLUSH MOUNTED COM ANTENNA (FLUSH MTD IN LEADING EDGE VERTICAL FIN MIC-HFADF COMBINATION, LIGHT WT REQUIRES FR9-C INSTALLATION, PADDED (STOWED) HFACSET-MICROPHONE, PADDED (STOWED) REQUIRES FB9-T INSTALLATION RECEIP TRANSPONDER IDENT SWITCH</p>	<p>0770750-741 3930208 3940148-2 3930186 3950126-40 3950126-9 3960102-9 3960113-2 3970147 3970137-2 3970139-1 3910185</p>	<p>1.0 0.1 0.1 0.4 0.8 0.8 0.5 1.9 0.3 0.3 1.0*</p>	<p>45.1 12.0 16.0 11.9 17.8 130.6 2 63.4 12.5 14.6 18.5 38.9*</p>
H46-A	<p>ANTENNA & COUPLER KIT (ROD & AVAILABLE WITH 2ND NAV/COM INSTL.) ANTENNA & CARLE, LF VHF CCM ADF ANTI PRECIP SENSE ANTENNA FLUSH MOUNTED COM ANTENNA (FLUSH MTD IN LEADING EDGE VERTICAL FIN MIC-HFADF COMBINATION, LIGHT WT REQUIRES FR9-C INSTALLATION, PADDED (STOWED) HFACSET-MICROPHONE, PADDED (STOWED) REQUIRES FB9-T INSTALLATION RECEIP TRANSPONDER IDENT SWITCH</p>	<p>S-2212-1 3910154-64 3910154-63 C596530-0101 C596531-0101 3910205</p>	<p>0.8 0.8 0.8 1.4 0.2 1.1 0.2</p>	<p>47.4 5.0 141.8 184.6 12.0 14.0 17.0</p>
H52-A	<p>ANTENNA & COUPLER KIT (ROD & AVAILABLE WITH 2ND NAV/COM INSTL.) ANTENNA & CARLE, LF VHF CCM ADF ANTI PRECIP SENSE ANTENNA FLUSH MOUNTED COM ANTENNA (FLUSH MTD IN LEADING EDGE VERTICAL FIN MIC-HFADF COMBINATION, LIGHT WT REQUIRES FR9-C INSTALLATION, PADDED (STOWED) HFACSET-MICROPHONE, PADDED (STOWED) REQUIRES FB9-T INSTALLATION RECEIP TRANSPONDER IDENT SWITCH</p>	<p>0770750-741 3930208 3940148-2 3930186 3950126-40 3950126-9 3960102-9 3960113-2 3970147 3970137-2 3970139-1 3910185</p>	<p>1.0 0.1 0.1 0.4 0.8 0.8 0.5 1.9 0.3 0.3 1.0*</p>	<p>45.1 12.0 16.0 11.9 17.8 130.6 2 63.4 12.5 14.6 18.5 38.9*</p>
H55-A	<p>ANTENNA & COUPLER KIT (ROD & AVAILABLE WITH 2ND NAV/COM INSTL.) ANTENNA & CARLE, LF VHF CCM ADF ANTI PRECIP SENSE ANTENNA FLUSH MOUNTED COM ANTENNA (FLUSH MTD IN LEADING EDGE VERTICAL FIN MIC-HFADF COMBINATION, LIGHT WT REQUIRES FR9-C INSTALLATION, PADDED (STOWED) HFACSET-MICROPHONE, PADDED (STOWED) REQUIRES FB9-T INSTALLATION RECEIP TRANSPONDER IDENT SWITCH</p>	<p>S-2212-1 3910154-64 3910154-63 C596530-0101 C596531-0101 3910205</p>	<p>0.8 0.8 0.8 1.4 0.2 1.1 0.2</p>	<p>47.4 5.0 141.8 184.6 12.0 14.0 17.0</p>
H56-A	<p>ANTENNA & COUPLER KIT (ROD & AVAILABLE WITH 2ND NAV/COM INSTL.) ANTENNA & CARLE, LF VHF CCM ADF ANTI PRECIP SENSE ANTENNA FLUSH MOUNTED COM ANTENNA (FLUSH MTD IN LEADING EDGE VERTICAL FIN MIC-HFADF COMBINATION, LIGHT WT REQUIRES FR9-C INSTALLATION, PADDED (STOWED) HFACSET-MICROPHONE, PADDED (STOWED) REQUIRES FB9-T INSTALLATION RECEIP TRANSPONDER IDENT SWITCH</p>	<p>0770750-741 3930208 3940148-2 3930186 3950126-40 3950126-9 3960102-9 3960113-2 3970147 3970137-2 3970139-1 3910185</p>	<p>1.0 0.1 0.1 0.4 0.8 0.8 0.5 1.9 0.3 0.3 1.0*</p>	<p>45.1 12.0 16.0 11.9 17.8 130.6 2 63.4 12.5 14.6 18.5 38.9*</p>
H70-A	<p>ANTENNA & COUPLER KIT (ROD & AVAILABLE WITH 2ND NAV/COM INSTL.) ANTENNA & CARLE, LF VHF CCM ADF ANTI PRECIP SENSE ANTENNA FLUSH MOUNTED COM ANTENNA (FLUSH MTD IN LEADING EDGE VERTICAL FIN MIC-HFADF COMBINATION, LIGHT WT REQUIRES FR9-C INSTALLATION, PADDED (STOWED) HFACSET-MICROPHONE, PADDED (STOWED) REQUIRES FB9-T INSTALLATION RECEIP TRANSPONDER IDENT SWITCH</p>	<p>S-2212-1 3910154-64 3910154-63 C596530-0101 C596531-0101 3910205</p>	<p>0.8 0.8 0.8 1.4 0.2 1.1 0.2</p>	<p>47.4 5.0 141.8 184.6 12.0 14.0 17.0</p>
J01-A	<p>J. SPECIAL OPTICS PACKAGES SKYLANE II KIT C07-A GROUND SERVICE RECEPTACLE C19-0 HEATED PITOT & STALL WARNING C-31-A COUNTSY ENTRANCE LIGHTS (2)</p>	<p>0701019-1 0770724-1 0700015-9</p>	<p>55.6* 3.2 0.5 0.5</p>	<p>53.3* 26.6 29.9 61.9</p>

CESSNA
MODEL 182Q

SECTION 6
WEIGHT & BALANCE/
EQUIPMENT LIST

ITEM NO	EQUIPMENT LIST DESCRIPTION	REF DRAWING	WT LBS	ARM INS
C40-A	NAV LIGHT DETECTORS	0701013	NEGL	-
C43-A	FLASHING BEACON LIGHT	0701014	1.0	208.6
C61-O	TRUE AIRSPEED IND. (NET CHANGE)	1201108	0.2	16.4
P49-A	STATIC ALTERNATE AIR SOURCE	0701028	0.2	18.2
E45-A	E. G. INDICATOR	0701011	0.7	14.5
G16-A	DUAL IC DISCHARGERS (SET OF 10)	1201131	0.4	10.5
H01-A	CESSNA 300 ADF (R-248E)	3910159	8.5	130.5
H22-A	CESSNA 300 TRANSPONDER (RT359A)	3910127	1.3	11.9
H28-A	CESSNA 300 NAV/CCM (RT-385A)	3910183	8.5	130.5
H31-A	EMERGENCY LOCATOR TRANSMITTER	0470419	3.5	51.6
H34-A	CESSNA 200A AUTO-PILOT	3910186	7.8	137.4
NAV-PAC	BASIC AVIONICS KIT	3910186	15.8	245.2*
H07-A	400 GLODESLOPE (R-243B)	3910157	0.0	107.0
H13-A	400 MARKER BEACON (R-402A)	3910164	2.5	41.9
H25-A	NAV/CCM 385A VCR/LOC 2ND UNIT	3910183	8.3	138.5
H37-A	ANTENNA & COUPLER KIT	3910185	1.0	18.5
J04-A				

SECTION 7 AIRPLANE & SYSTEMS DESCRIPTIONS

TABLE OF CONTENTS



	Page
Introduction	7-3
Airframe	7-3
Flight Controls	7-8
Trim Systems	7-8
Instrument Panel	7-8
Ground Control	7-9
Wing Flap System	7-10
Landing Gear System	7-11
Baggage Compartment	7-11
Seats	7-11
Seat Belts And Shoulder Harnesses	7-12
Seat Belts	7-12
Shoulder Harnesses	7-14
Integrated Seat Belt/Shoulder Harnesses With Inertia Reels	7-14
Entrance Doors And Cabin Windows	7-15
Control Locks	7-16
Engine	7-16
Engine Controls	7-16
Engine Instruments	7-17
New Engine Break-In And Operation	7-18
Engine Oil System	7-18
Ignition-Starter System	7-19
Air Induction System	7-19
Exhaust System	7-20
Carburetor And Priming System	7-20
Cooling System	7-20
Propeller	7-21
Fuel System	7-21
Brake System	7-25
Electrical System	7-25
Master Switch	7-27
Avionics Power Switch	7-27
Ammeter	7-27

TABLE OF CONTENTS (Continued)

	Page
Alternator Control Unit And Low-Voltage Warning Light . . .	7-28
Circuit Breakers And Fuses	7-28
Ground Service Plug Receptacle	7-29
Lighting Systems	7-29
Exterior Lighting	7-29
Interior Lighting	7-29
Cabin Heating, Ventilating And Defrosting System	7-31
Pitot-Static System And Instruments	7-33
Airspeed Indicator	7-33
Vertical Speed Indicator	7-34
Altimeter	7-34
Vacuum System And Instruments	7-34
Attitude Indicator	7-36
Directional Indicator	7-36
Suction Gage	7-36
Stall Warning System	7-36
Avionics Support Equipment	7-37
Audio Control Panel	7-37
Transmitter Selector Switch	7-37
Audio Selector Switches	7-39
Com Auto Audio Selector Switch	7-39
Com Both Audio Selector Switch	7-40
Auto Audio Selector Switch	7-40
Annunciator Lights Brightness And Test Switch	7-41
Sidetone Operation	7-41
Microphone - Headset Installations	7-42
Static Dischargers	7-42

INTRODUCTION

This section provides description and operation of the airplane and its systems. Some equipment described herein is optional and may not be installed in the airplane. Refer to Section 9, Supplements, for details of other optional systems and equipment.

AIRFRAME

The airplane is an all-metal, four-place, high-wing, single-engine airplane equipped with tricycle landing gear and designed for general utility purposes.

The construction of the fuselage is a conventional formed sheet metal bulkhead, stringer, and skin design referred to as semimonocoque. Major items of structure are the front and rear carry-through spars to which the wings are attached, a bulkhead and forgings for main landing gear attachment at the base of the rear door posts, and a bulkhead with attaching plates at the base of the forward door posts for the lower attachment of the wing struts. Four engine mount stringers are also attached to the forward door posts and extend forward to the firewall.

The externally braced wings, containing the fuel tanks, are constructed of a front and rear spar with formed sheet metal ribs, doublers, and stringers. The entire structure is covered with aluminum skin. The front spars are equipped with wing-to-fuselage and wing-to-strut attach fittings. The aft spars are equipped with wing-to-fuselage attach fittings, and are partial-span spars. Conventional hinged ailerons and single-slot type flaps are attached to the trailing edge of the wings. The ailerons are constructed of a forward spar containing balance weights, formed sheet metal ribs and "V" type corrugated aluminum skin joined together at the trailing edge. The flaps are constructed basically the same as the ailerons, with the exception of balance weights and the addition of a formed sheet metal leading edge section.

The empennage (tail assembly) consists of a conventional vertical stabilizer, rudder, horizontal stabilizer, and elevator. The vertical stabilizer consists of a forward and aft spar, formed sheet metal ribs and reinforcements, four skin panels, formed leading edge skins, and a dorsal. The rudder is constructed of a forward and aft spar, formed sheet metal ribs and reinforcements, and a wrap-around skin panel. The top of the rudder incorporates a leading edge extension which contains a balance weight. The horizontal stabilizer is constructed of a forward and aft spar, ribs and stiffeners, center upper and lower skin panels, and two left and two right wrap-around skin panels which also form the leading edges. The horizon-

AILERON CONTROL SYSTEM

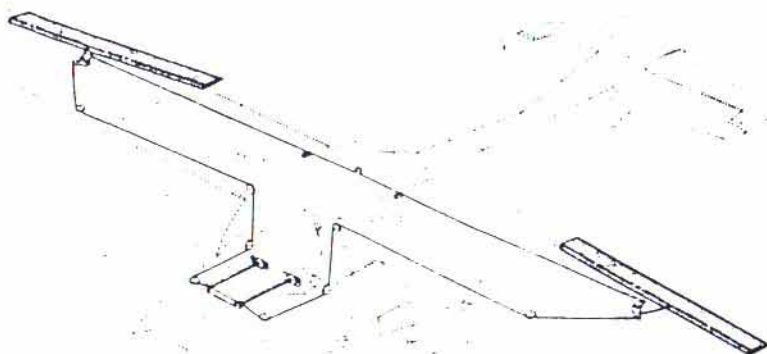

RUDDER AND RUDDER TRIM CONTROL SYSTEMS

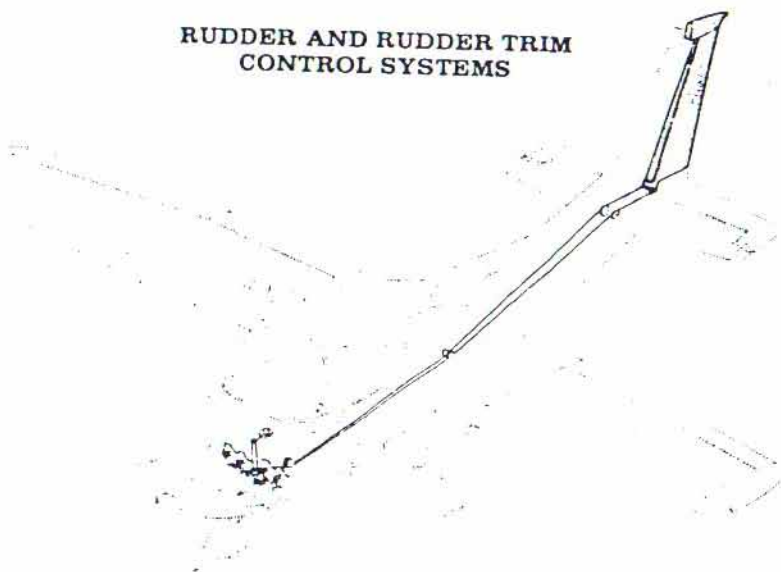
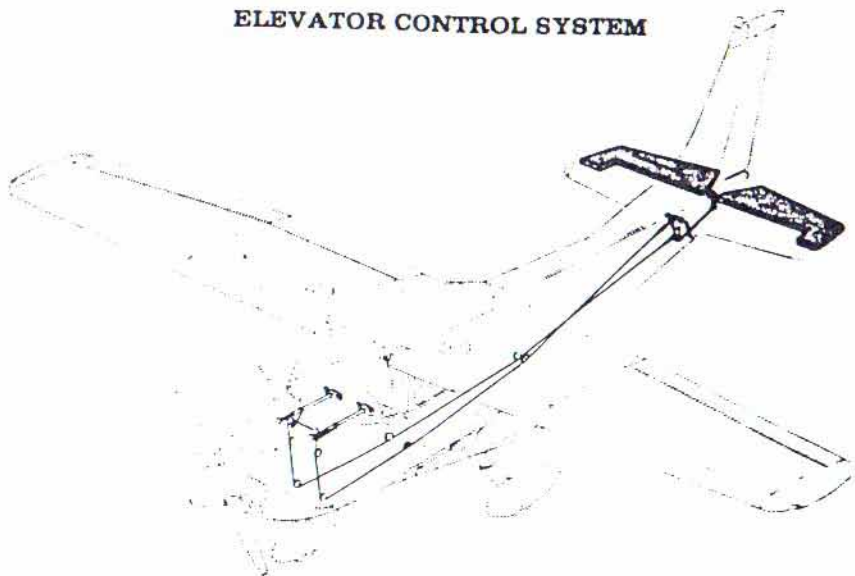

Figure 7-1. Flight Control and Trim Systems (Sheet 1 of 2)

ELEVATOR CONTROL SYSTEM



ELEVATOR TRIM CONTROL SYSTEM

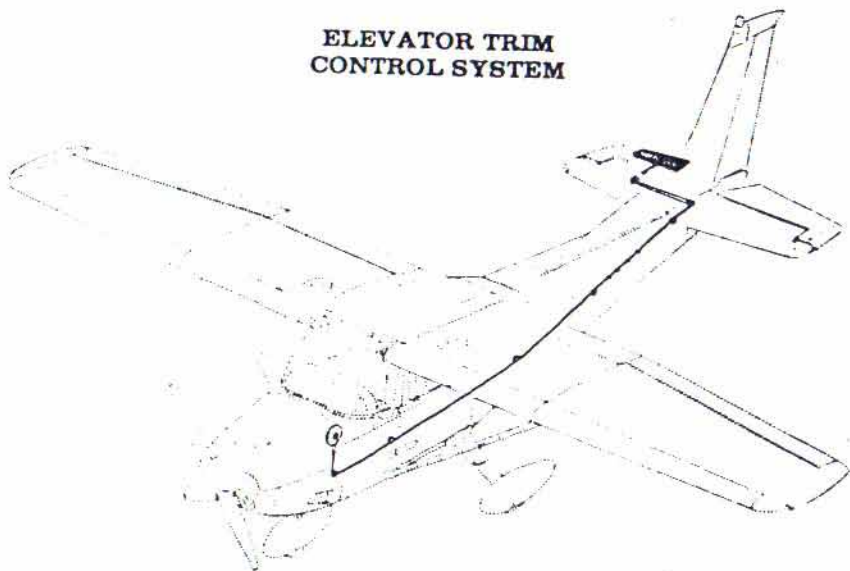

Figure 7-1. Flight Control and Trim Systems (Sheet 2 of 2)

1.	Master Switch	29.	Cassette Stereo, AM/FM Multiplex Radio
2.	Phone and Auxiliary Mike Jacks	30.	Map Compartment
3.	Digital Clock	31.	Defroster Control Knob
4.	Suction Gage	32.	Cabin Air Control Knob
5.	Electric Elevator Trim Switch	33.	Cabin Heat Control Knob
6.	Airplane Registration Number	34.	Cigar Lighter
7.	Flight Instrument Group	35.	Wing Flap Switch and Position Indicator
8.	Carburetor Air Temperature Gage	36.	Mixture Control Knob
9.	Approach Plate Holder	37.	Propeller Control Knob
10.	Approach Plate Light and Switch	38.	Throttle (With Friction Lock)
11.	Encoding Altimeter	39.	Electric Elevator Trim
12.	Course Deviation and ILS		Circuit Breaker
13.	Glide Slope Indicators	40.	Control Pedestal Light
14.	DME	41.	Rudder Trim Control Wheel and Position Indicator
15.	Marker Beacon Indicator Lights and Switches	42.	Cowl Flap Control Lever
16.	Autopilot Control Unit	43.	Microphone
17.	Audio Control Panel	44.	Fuel Selector Light
18.	ADF Radio	45.	Fuel Selector Valve Handle
19.	Nav/Com Radios	46.	Elevator Trim Control Wheel and Position Indicator
20.	Transponder	47.	Carburetor Heat Control Knob
21.	Manifold Pressure Gage	48.	Electrical Switches
22.	Tachometer	49.	Static Pressure Alternate Source Valve
23.	Fuel Quantity Indicators and Ammeter	50.	Parking Brake Handle
24.	Cylinder Head Temperature, Oil Temperature, and Oil Pressure Gages	51.	Instrument and Radio Dial Light Dimming Rheostats
25.	Low-Voltage Warning Light	52.	Avionics Power Switch
26.	Economy Mixture Indicator	53.	Circuit Breakers
27.	Flight Hour Recorder	54.	Ignition Switch
28.	ADP Heading Indicator	55.	Primer
	Secondary Altimeter		

Figure 7-2. Instrument Panel (Sheet 2 of 2)

tal stabilizer also contains the elevator trim tab actuator. Construction of the elevator consists of formed leading edge skins, a forward spar, ribs, torque tube and bellcrank, left upper and lower "V" type corrugated skins, and right upper and lower "V" type corrugated skins incorporating a trailing edge cut-out for the trim tab. The elevator trim tab consists of a spar and upper and lower "V" type corrugated skins. Both elevator tip leading edge extensions incorporate balance weights.

FLIGHT CONTROLS

The airplane's flight control system (see figure 7-1) consists of conventional aileron, rudder, and elevator control surfaces. The control surfaces are manually operated through mechanical linkage using a control wheel for the ailerons and elevator, and rudder/brake pedals for the rudder. The elevator control system is equipped with downsprings which provide improved stability in flight.

Extensions are available for the rudder/brake pedals. They consist of a rudder pedal face, two spacers and two spring clips. To install an extension, place the clip on the bottom of the extension under the bottom of the rudder pedal and snap the top clip over the top of the rudder pedal. Check that the extension is firmly in place. To remove the extensions, reverse the above procedures.

TRIM SYSTEMS

Manually-operated rudder and elevator trim is provided (see figure 7-1). Rudder trimming is accomplished through a bungee connected to the rudder control system and a trim control wheel mounted on the control pedestal. Rudder trimming is accomplished by rotating the horizontally mounted trim control wheel either left or right to the desired trim position. Rotating the trim wheel to the right will trim nose-right; conversely rotating it to the left will trim nose-left. Elevator trimming is accomplished through the elevator trim tab by utilizing the vertically mounted trim control wheel. Forward rotation of the trim wheel will trim nose-down; conversely, aft rotation will trim nose-up. The airplane may also be equipped with an electric elevator trim system. For details concerning this system, refer to Section 9, Supplements.

INSTRUMENT PANEL

The instrument panel (see figure 7-2) is designed around the basic "T" configuration. The gyros are located immediately in front of the pilot, and

arranged vertically. The airspeed indicator and altimeter are located to the left and right of the gyros, respectively. The remainder of the flight instruments are located around the basic "T". Avionics equipment is stacked approximately on the centerline of the panel, with the right side of the panel containing the manifold pressure gage, low-voltage warning light, tachometer, map compartment, and space for additional instruments and avionics equipment. The engine instrument cluster and fuel quantity indicators are on the right side of the avionics stack near the top of the panel. A switch and control panel, at the lower edge of the instrument panel, contains most of the switches, controls, and circuit breakers necessary to operate the airplane. The left side of the panel contains the master switch, engine primer, ignition switch, avionics power switch, light intensity controls, electrical switches, and circuit breakers. The center area contains the carburetor heat control, throttle, propeller control, and mixture control. The right side of the panel contains the wing flap switch and position indicator, cabin heat, cabin air, and defroster control knobs and the cigar lighter. A pedestal, extending from the switch and control panel to the floorboard, contains the elevator and rudder trim control wheels, cowl flap control lever, and microphone bracket. The fuel selector valve handle is located at the base of the pedestal. A parking brake handle is mounted below the switch and control panel, in front of the pilot. A static pressure alternate source valve control knob may also be installed below the switch and control panel adjacent to the parking brake handle.

For details concerning the instruments, switches, circuit breakers, and controls on this panel, refer in this section to the description of the systems to which these items are related.

GROUND CONTROL

Effective ground control while taxiing is accomplished through nose wheel steering by using the rudder pedals; left rudder pedal to steer left and right rudder pedal to steer right. When a rudder pedal is depressed, a spring-loaded steering bungee (which is connected to the nose gear and to the rudder bars) will turn the nose wheel through an arc of approximately 11° each side of center. By applying either left or right brake, the degree of turn may be increased up to 29° each side of center.

Moving the airplane by hand is most easily accomplished by attaching a tow bar to the nose gear strut. If a tow bar is not available, or pushing is required, use the wing struts as push points. Do not use the vertical or horizontal surfaces to move the airplane. If the airplane is to be towed by vehicle, never turn the nose wheel more than 29° either side of center or structural damage to the nose gear could result.

The minimum turning radius of the airplane, using differential braking and nose wheel steering during taxi, is approximately 27 feet. To obtain a minimum radius turn during ground handling, the airplane may be rotated around either main landing gear by pressing down on a tailcone bulkhead just forward of the horizontal stabilizer to raise the nose wheel off the ground.

WING FLAP SYSTEM

The single-slot type wing flaps (see figure 7-3), are extended or retracted by positioning the wing flap switch lever on the right side of the switch and control panel to the desired flap deflection position. The switch lever is moved up or down in a slotted panel that provides mechanical stops at the 10° and 20° positions. For flap settings greater than 10°, move the switch lever to the right to clear the stop and position it as desired. A scale and pointer on the left side of the switch lever indicates flap travel in degrees. The wing flap system circuit is protected by a 15-amp push-to-reset circuit breaker, labeled FLAP, on the left side of the switch and control panel.

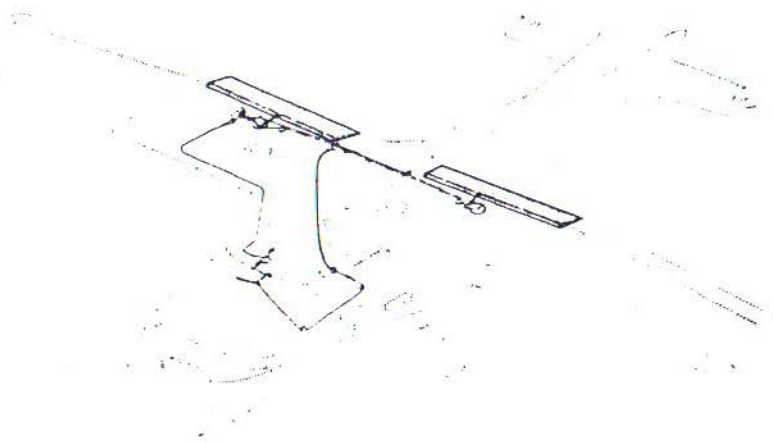

Figure 7-3. Wing Flap System

LANDING GEAR SYSTEM

The landing gear is of the tricycle type with a steerable nose wheel, two main wheels, and wheel fairings. Shock absorption is provided by the tubular spring-steel main landing gear struts and the air/oil nose gear shock strut. Each main gear wheel is equipped with a hydraulically actuated single-disc brake on the inboard side of each wheel, and an aerodynamic fairing over each brake.

BAGGAGE COMPARTMENT

The baggage compartment consists of the area from the back of the rear passenger seats to the aft cabin bulkhead. Mounted to the aft cabin bulkhead, and extending aft of it, is a hatshelf. Access to the baggage compartment and the hatshelf is gained through a lockable baggage door on the left side of the airplane, or from within the airplane cabin. A baggage net with six tie-down straps is provided for securing baggage and is attached by tying the straps to tie-down rings provided in the airplane. A cargo tie-down kit may also be installed. For further information on baggage and cargo tie-down, refer to Section 6. When loading the airplane, children should not be placed or permitted in the baggage compartment and any material that might be hazardous to the airplane or occupants should not be placed anywhere in the airplane. For baggage area and door dimensions, refer to Section 6.

SEATS

The seating arrangement consists of two individually adjustable four-way or six-way seats for the pilot and front seat passenger, and a split-backed fixed seat for the rear seat passengers. A child's seat (if installed) is located at the aft cabin bulkhead behind the rear seat.

The four-way seats may be moved forward or aft, and the seat back angle is infinitely adjustable. To position the seat, lift the tubular handle below the center of the seat frame, slide the seat into position, release the handle, and check that the seat is locked in place. The seat back is controlled by a cylinder lock release button which is spring-loaded to the locked position. The release button is located on the right side, below the forward corner of the seat cushion. To adjust the angle of the seat back, push up on the release button, position the seat back to the desired angle and release the button. When the seat is not occupied, the seat back will automatically fold forward whenever the release button is pushed up.

The six-way seats may be moved forward or aft, and are infinitely adjustable for height and seat back angle. To position the seat, lift the tubular handle under the center of the seat bottom, slide the seat into position, release the handle, and check that the seat is locked in place. Raise or lower the seat by rotating the large crank under the inboard corner of either seat. The seat back is adjusted by rotating the small crank under the outboard corner of either seat. The seat bottom angle will change as the seat back angle changes, providing proper support. The seat backs will also fold full forward.

The rear passengers' seat consists of a fixed one-piece seat bottom with individual infinitely adjustable seat backs. The seat back angle is controlled by cylinder lock release buttons which are spring-loaded to the locked position. The buttons are recessed into skirts located below the forward edge of the seat cushion near the outboard ends. To adjust the angle of a seat back, push up on the release button, position the seat back to the desired angle and release the button. When the seats are not occupied, the seat backs will automatically fold forward whenever the release buttons are pushed up.

A child's seat may be installed aft of the rear passengers' seat, and is held in place by two brackets mounted on the floorboard. The seat is designed to swing upward into a stowed position against the aft cabin bulkhead when not in use. To stow the seat, rotate the seat bottom up and aft as far as it will go. When not in use, the seat should be kept in the stowed position.

Headrests are available for any of the seat configurations except the child's seat. To adjust the headrest, apply enough pressure to it to raise or lower it to the desired level. The headrest may be removed at any time by raising it until it disengages from the top of the seat back.

SEAT BELTS AND SHOULDER HARNESSSES

All seat positions are equipped with seat belts (see figure 7-4). The pilot's and front passenger's seats are also equipped with separate shoulder harnesses; separate shoulder harnesses are also available for the rear seat positions. Integrated seat belt/shoulder harnesses with inertia reels can be furnished for the pilot's and front passenger's seat positions if desired.

SEAT BELTS

The seat belts used with the pilot's and front passenger's seats, and the child's seat (if installed), are attached to fittings on the floorboard. The

STANDARD SHOULDER
HARNESS

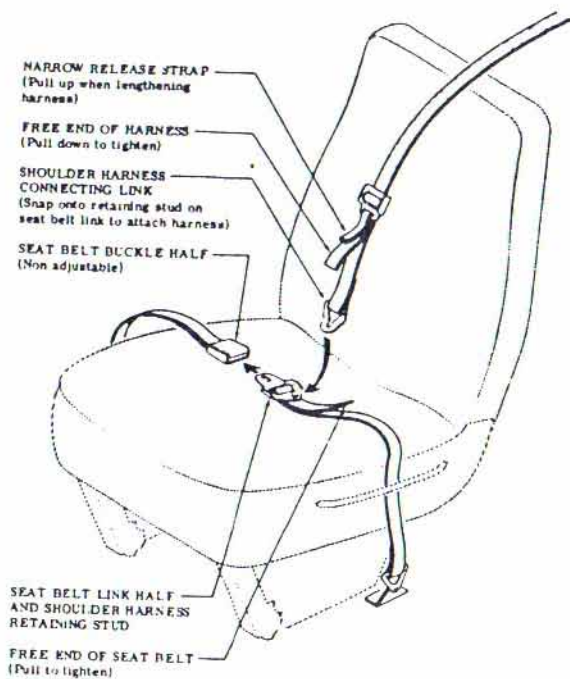

Figure 7-4. Seat Belts and Shoulder Harnesses

buckle half is inboard of each seat and the link half is outboard of each seat. The belts for the rear seat are attached to the seat frame, with the link halves on the left and right sides of the seat bottom, and the buckles at the center of the seat bottom.

To use the seat belts for the front seats, position the seat as desired, and then lengthen the link half of the belt as needed by grasping the sides of the link and pulling against the belt. Insert and lock the belt link into the buckle. Tighten the belt to a snug fit. Seat belts for the rear seat and the child's seat, are used in the same manner as the belts for the front seats. To release the seat belts, grasp the top of the buckle opposite the link and pull upward.

SHOULDER HARNESSES

Each front seat shoulder harness is attached to a rear doorpost above the window line and is stowed behind a stowage sheath above the cabin door. To stow the harness, fold it and place it behind the sheath. When rear seat shoulder harnesses are furnished, they are attached adjacent to the lower corners of the aft side windows. Each rear seat harness is stowed behind a stowage sheath above an aft side window. No harness is available for the child's seat.

To use a front or rear seat shoulder harness, fasten and adjust the seat belt first. Lengthen the harness as required by pulling on the connecting link on the end of the harness and the narrow release strap. Snap the connecting link firmly onto the retaining stud on the seat belt link half. Then adjust to length. A properly adjusted harness will permit the occupant to lean forward enough to sit completely erect, but prevent excessive forward movement and contact with objects during sudden deceleration. Also, the pilot will want the freedom to reach all controls easily.

Removing the shoulder harness is accomplished by pulling upward on the narrow release strap, and removing the harness connecting link from the stud on the seat belt link. In an emergency, the shoulder harness may be removed by releasing the seat belt first and allowing the harness, still attached to the link half of the seat belt, to drop to the side of the seat.

INTEGRATED SEAT BELT/SHOULDER HARNESSES WITH INERTIA REELS

Integrated seat belt/shoulder harnesses with inertia reels are available for the pilot and front seat passenger. The seat belt/shoulder harnesses extend from inertia reels located in the cabin top structure, through slots in the overhead console marked PILOT and COPILOT, to attach points inboard of the two front seats. A separate seat belt half and buckle is

located outboard of the seats. Inertia reels allow complete freedom of body movement. However, in the event of a sudden deceleration, they will lock automatically to protect the occupants.

To use the seat belt/shoulder harness, position the adjustable metal link on the harness at about shoulder level, pull the link and harness downward, and insert the link in the seat belt buckle. Adjust belt tension across the lap by pulling upward on the shoulder harness. Removal is accomplished by releasing the seat belt buckle, which will allow the inertia reel to pull the harness inboard of the seat.

ENTRANCE DOORS AND CABIN WINDOWS

Entry to, and exit from the airplane is accomplished through either of two entry doors, one on each side of the cabin at the front seat positions (refer to Section 6 for cabin and cabin door dimensions). The doors incorporate a recessed exterior door handle, a conventional interior door handle, a key-operated door lock (left door only), a door stop mechanism, and an openable window in the left door. An openable right door window is also available.

To open the doors from outside the airplane, utilize the recessed door handle near the aft edge of each door. Depress the forward end of the handle to rotate it out of its recess, and then pull outward. To close or open the doors from inside the airplane, use the combination door handle and arm rest. The inside door handle has three positions and a placard at its base which reads OPEN, CLOSE, and LOCK. The handle is spring-loaded to the CLOSE (up) position. When the door has been pulled shut and latched, lock it by rotating the door handle forward to the LOCK position (flush with the arm rest). When the handle is rotated to the LOCK position, an over-center action will hold it in that position. Both cabin doors should be locked prior to flight, and should not be opened intentionally during flight.

NOTE

Accidental opening of a cabin door in flight due to improper closing does not constitute a need to land the airplane. The best procedure is to set up the airplane in a trimmed condition at approximately 80 KIAS, open a window, momentarily shove the door outward slightly and forcefully close and lock the door.

Exit from the airplane is accomplished by rotating the door handle from the LOCK position, past the CLOSE position, aft to the OPEN position and pushing the door open. To lock the airplane, lock the right cabin door.

with the inside handle, close the left cabin door, and using the ignition key, lock the door.

The left cabin door is equipped with an openable window which is held in the closed position by a detent equipped latch on the lower edge of the window frame. To open the window, rotate the latch upward. The window is equipped with a spring-loaded retaining arm which will help rotate the window outward and hold it there. An openable window is also available for the right door, and functions in the same manner as the left window. If required, either window may be opened at any speed up to 179 KIAS. The cabin top windows (if installed), rear side windows, and rear window are of the fixed type and cannot be opened.

CONTROL LOCKS

A control lock is provided to lock the aileron and elevator control surfaces to prevent damage to these systems by wind buffeting while the airplane is parked. The lock consists of a shaped steel rod with a red metal flag attached to it. The flag is labeled CONTROL LOCK. REMOVE BEFORE STARTING ENGINE. To install the control lock, align the hole in the top of the pilot's control wheel shaft with the hole in the top of the shaft collar on the instrument panel and insert the rod into the aligned holes. Installation of the lock will secure the ailerons in a neutral position and the elevators in a slightly trailing edge down position. Proper installation of the lock will place the red flag over the ignition switch. In areas where high or gusty winds occur, a control surface lock should be installed over the vertical stabilizer and rudder. The control lock and any other type of locking device should be removed prior to starting the engine.

ENGINE

The airplane is powered by a horizontally-opposed, six-cylinder, overhead-valve, air-cooled, carbureted engine with a wet sump oil system. The engine is a Continental Model O-470-U and is rated at 230 horsepower at 2400 RPM. Major accessories include a propeller governor on the front of the engine and dual magnetos, starter, belt-driven alternator, and vacuum pump on the rear of the engine. Provisions are also made for a full flow oil filter.

ENGINE CONTROLS

Engine manifold pressure is controlled by a throttle located on the center area of the switch and control panel. The throttle operates in a

conventional manner; in the full forward position, the throttle is open, and in the full aft position, it is closed. A friction lock, which is a round knurled disk, is located at the base of the throttle and is operated by rotating the lock clockwise to increase friction or counterclockwise to decrease it.

The mixture control, mounted near the propeller control, is a red knob with raised points around the circumference and is equipped with a lock button in the end of the knob. The rich position is full forward, and full aft is the idle cut-off position. For small adjustments, the control may be moved forward by rotating the knob clockwise, and aft by rotating the knob counterclockwise. For rapid or large adjustments, the knob may be moved forward or aft by depressing the lock button in the end of the control, and then positioning the control as desired.

ENGINE INSTRUMENTS

Engine operation is monitored by the following instruments: oil pressure gage, oil temperature gage, cylinder head temperature gage, tachometer, and manifold pressure gage. An economy mixture (EGT) indicator and carburetor air temperature gage are also available.

The oil pressure gage, located on the right side of the instrument panel, is operated by oil pressure. A direct pressure oil line from the engine delivers oil at engine operating pressure to the oil pressure gage. Gage markings indicate that minimum idling pressure is 10 PSI (red line), the normal operating range is 30 to 60 PSI (green arc), and maximum pressure is 100 PSI (red line).

Oil temperature is indicated by a gage adjacent to the oil pressure gage. The gage is operated by an electrical-resistance type temperature sensor which receives power from the airplane electrical system. Gage markings indicate the normal operating range (green arc) which is 100°F (38°C) to 240°F (116°C), and the maximum (red line) which is 240°F (116°C).

The cylinder head temperature gage, under the left fuel quantity indicator, is operated by an electrical-resistance type temperature sensor on the engine which receives power from the airplane electrical system. Gage markings indicate the normal operating range (green arc) which is 200°F (93°C) to 460°F (238°C) and the maximum (red line) which is 460°F (238°C).

The engine-driven mechanical tachometer is located on the lower right side of the instrument panel. The instrument is calibrated in increments of 100 RPM and indicates both engine and propeller speed. An hour meter below the center of the tachometer dial records elapsed engine time in hours and tenths. Instrument markings include a normal operating range

(green arc) of 2100 to 2400 RPM, and a maximum allowable (red line) of 2400 RPM.

The manifold pressure gage is located on the right side of the instrument panel above the tachometer. The gage is direct reading and indicates induction air manifold pressure in inches of mercury. It has a normal operating range (green arc) of 15 to 23 inches of mercury.

An economy mixture (EGT) indicator is available for the airplane and is located on the right side of the instrument panel. A thermocouple probe in the right exhaust stack assembly measures exhaust gas temperature and transmits it to the indicator. The indicator serves as a visual aid to the pilot in adjusting cruise mixture. Exhaust gas temperature varies with fuel-to-air ratio, power, and RPM. However, the difference between the peak EGT and the EGT at the cruise mixture setting is essentially constant and this provides a useful leaning aid. The indicator is equipped with a manually positioned reference pointer.

A carburetor air temperature gage is available for the airplane. Details of this gage are presented in Section 9, Supplements.

NEW ENGINE BREAK-IN AND OPERATION

The engine underwent a run-in at the factory and is ready for the full range of use. It is, however, suggested that cruising be accomplished at 75% power until a total of 50 hours has accumulated or oil consumption has stabilized. This will ensure proper seating of the rings.

The airplane is delivered from the factory with corrosion preventive oil in the engine. If, during the first 25 hours, oil must be added, use only aviation grade straight mineral oil conforming to Specification No. MIL-L-6082.

ENGINE OIL SYSTEM

Oil for engine lubrication and propeller governor operation is supplied from a sump on the bottom of the engine. The capacity of the sump is 12 quarts (one additional quart is required if a full flow oil filter is installed). Oil is drawn from the sump through a filter screen on the end of a pickup tube to the engine-driven oil pump. Oil from the pump passes through an oil pressure screen (full flow oil filter, if installed), a pressure relief valve at the rear of the right oil gallery, and a thermostatically controlled oil cooler. Oil from the cooler is then circulated to the left gallery and propeller governor. The engine parts are then lubricated by oil from the galleries. After lubricating the engine, the oil returns to the sump by gravity. If a full flow oil filter is installed, the filter adapter is equipped with a bypass valve which will cause lubricating oil to bypass the filter in

the event the filter becomes plugged, or the oil temperature is extremely cold.

An oil dipstick is located at the rear of the engine on the left side, and an oil filler tube is on top of the crankcase near the front of the engine. The dipstick and oil filler are accessible through doors on the engine cowling. The engine should not be operated on less than nine quarts of oil. To minimize loss of oil through the breather, fill to 10 quarts for normal flights of less than three hours. For extended flight, fill to 12 quarts (dipstick indication only). For engine oil grade and specifications, refer to Section 8 of this handbook.

The oil cooler may be replaced by a non-congealing oil cooler for operations in temperatures consistently below 20°F (-7°C). The non-congealing oil cooler provides improved oil flow at low temperatures. Once installed, the non-congealing oil cooler is approved for permanent use in both hot and cold weather.

An oil quick-drain valve is available to replace the drain plug on the bottom of the oil sump, and provides quicker, cleaner draining of the engine oil. To drain the oil with this valve installed, slip a hose over the end of the valve and push upward on the end of the valve until it snaps into the open position. Spring clips will hold the valve open. After draining, use a suitable tool to snap the valve into the extended (closed) position and remove the drain hose.

IGNITION-STARTER SYSTEM

Engine ignition is provided by two engine-driven magnetos, and two spark plugs in each cylinder. The right magneto fires the lower left and upper right spark plugs, and the left magneto fires the lower right and upper left spark plugs. Normal operation is conducted with both magnetos due to the more complete burning of the fuel-air mixture with dual ignition.

Ignition and starter operation is controlled by a rotary type switch located on the left switch and control panel. The switch is labeled clockwise, OFF, R, L, BOTH, and START. The engine should be operated on both magnetos (BOTH position) except for magneto checks. The R and L positions are for checking purposes and emergency use only. When the switch is rotated to the spring-loaded START position, (with the master switch in the ON position), the starter contactor is energized and the starter will crank the engine. When the switch is released, it will automatically return to the BOTH position.

AIR INDUCTION SYSTEM

The engine air induction system receives ram air through an intake

the lower front portion of the engine cowling. The intake is covered by an air filter which removes dust and other foreign matter from the induction air. Airflow passing through the filter enters an airbox. After passing through the airbox, induction air enters the inlet in the carburetor which is under the engine, and is then ducted to the engine cylinders through intake manifold tubes. In the event carburetor ice is encountered or the intake filter becomes blocked, alternate heated air can be obtained from a shroud around an exhaust riser through a duct to a valve, in the airbox, operated by the carburetor heat control on the instrument panel. Heated air from the exhaust riser shroud is obtained from unfiltered air inside the cowling. Use of full carburetor heat at full throttle will result in a loss of approximately one to two inches of manifold pressure.

EXHAUST SYSTEM

Exhaust gas from each cylinder passes through riser assemblies to a muffler and tailpipe. The muffler is constructed with a shroud around the outside which forms a heating chamber for cabin heater air.

CARBURETOR AND PRIMING SYSTEM

The engine is equipped with an up-draft, float-type, fixed jet carburetor mounted on the bottom of the engine. The carburetor is equipped with an enclosed accelerator pump, an idle cut-off mechanism, and a manual mixture control. Fuel is delivered to the carburetor by gravity flow from the fuel system. In the carburetor, fuel is atomized, proportionally mixed with intake air, and delivered to the cylinders through intake manifold tubes. The proportion of atomized fuel to air may be controlled, within limits, by the mixture control on the instrument panel.

To facilitate starting in cold weather, the engine is equipped with a manual primer. The primer is actually a small pump which draws fuel from the fuel strainer when the plunger is pulled out, and injects it into the intake manifold when the plunger is pushed back in. The plunger is equipped with a lock and, after being pushed full in, must be rotated either left or right until the knob cannot be pulled out. A six-port primer is available which injects the fuel into individual cylinder intake ports in lieu of the intake manifold. Both primers are identical in appearance, except for the plumbing, and operate in the same manner.

COOLING SYSTEM

Ram air for engine cooling enters through two intake openings in the front of the engine cowling. The cooling air is directed around the cylinders and other areas of the engine by baffling, and is then exhausted through cowl flaps on the lower aft edge of the cowling. The cowl flaps are mechanically operated from the cabin by means of a cowl flap lever on the

right side of the control pedestal. The pedestal is labeled OPEN, COWL FLAPS, CLOSED. Before starting the engine, takeoff and high power operation, the cowl flap lever should be placed in the OPEN position for maximum cooling. This is accomplished by moving the lever to the right to clear a detent, then moving the lever up to the OPEN position. Anytime the lever is repositioned, it must first be moved to the right. While in cruise flight, cowl flaps should be adjusted to keep the cylinder head temperature at approximately two-thirds of the normal operating range (green arc). During extended let-downs, it may be necessary to completely close the cowl flaps by pushing the cowl flap lever down to the CLOSED position.

A winterization kit is available for the airplane. Details of this kit are presented in Section 9, Supplements.

PROPELLER

The airplane has an all-metal, two-bladed, constant-speed, governor-regulated propeller. A setting introduced into the governor with the propeller control establishes the propeller speed, and thus the engine speed to be maintained. The governor then controls flow of engine oil, boosted to high pressure by the governing pump, to or from a piston in the propeller hub. Oil pressure acting on the piston twists the blades toward high pitch (low RPM). When oil pressure to the piston in the propeller hub is relieved, centrifugal force, assisted by an internal spring, twists the blades toward low pitch (high RPM).

A control knob on the center area of the switch and control panel is used to set the propeller and control engine RPM as desired for various flight conditions. The knob is labeled PROP PITCH, PUSH INCR RPM. When the control knob is pushed in, blade pitch will decrease, giving a higher RPM. When the control knob is pulled out, the blade pitch increases, thereby decreasing RPM. The propeller control knob is equipped with a vernier feature which allows slow or fine RPM adjustments by rotating the knob clockwise to increase RPM, and counterclockwise to decrease it. To make rapid or large adjustments, depress the button on the end of the control knob and reposition the control as desired.

FUEL SYSTEM

The airplane fuel system (see figure 7-5) consists of two vented integral fuel tanks (one in each wing), a four-position selector valve, fuel strainer, manual primer and carburetor. Refer to figure 7-6 for fuel quantity data for the system.

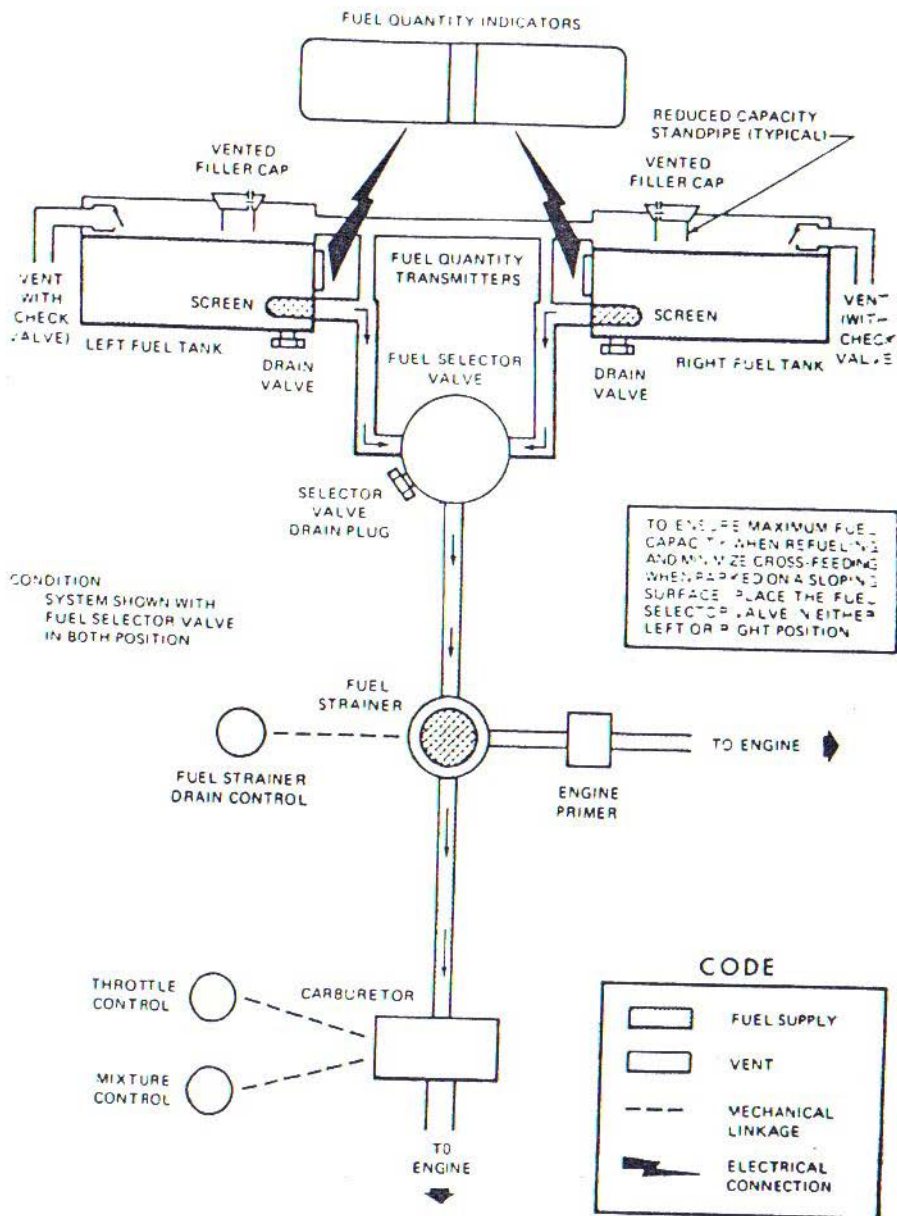

Figure 7-5. Fuel System

Fuel flows by gravity from the two integral wing tanks to a four-position selector valve, labeled BOTH, RIGHT, LEFT, and OFF. With the selector valve in either the BOTH, RIGHT, or LEFT position, fuel flows through a strainer to the carburetor. From the carburetor, mixed fuel and air flows to the cylinders through intake manifold tubes. The manual primer draws its fuel from the fuel strainer and injects it into the intake manifold.

The airplane may be serviced to a reduced capacity to permit heavier cabin loadings. This is accomplished by filling each tank to the bottom edge of the fuel filler neck, thus giving a reduced fuel load of 34.5 gallons in each tank (32.5 gallons usable in all flight conditions).

Fuel system venting is essential to system operation. Complete blockage of the venting system will result in a decreasing fuel flow and eventual engine stoppage. Venting consists of an interconnecting vent line between the tanks, and check valve equipped overboard vents in each tank. The overboard vents protrude from the bottom surfaces of the wings behind the wing struts, slightly below the upper attach points of the struts. The fuel filler caps are vacuum vented; the vents will open and allow air to enter the fuel tanks in case the overboard vents become blocked.

Fuel quantity is measured by two float-type fuel quantity transmitters (one in each fuel tank) and indicated by two electrically-operated fuel quantity indicators on the right side of the instrument panel. The fuel quantity indicators are calibrated in gallons (lower scale) and pounds (upper scale). An empty tank is indicated by a red line and the letter E. When an indicator shows an empty tank, approximately 2.0 gallons remain in a tank as unusable fuel. The indicators cannot be relied upon for accurate readings during skids, slips, or unusual flight attitudes. If both indicator pointers should rapidly move to a zero reading, check the

FUEL QUANTITY DATA (U. S. GALLONS)			
TANKS	TOTAL USABLE FUEL ALL FLIGHT CONDITIONS	TOTAL UNUSABLE FUEL	TOTAL FUEL VOLUME
STANDARD (46 Gal. Each)	88	4	92
REDUCED FUEL (34.5 Gal. Each)	65	4	69

Figure 7-6. Fuel Quantity Data

cylinder head temperature and oil temperature gages for operation. If these gages are not indicating, an electrical malfunction has occurred.

The fuel selector valve should be in the BOTH position for takeoff, climb, descent, landing, and maneuvers that involve prolonged slips or skids. Operation from either LEFT or RIGHT tank is reserved for level cruising flight only.

NOTE

Unusable fuel is at a minimum due to the design of the fuel system. However, with 1/4 tank or less, prolonged uncoordinated flight such as slips or skids can uncover the fuel tank outlets, causing fuel starvation and engine stoppage. Therefore, with low fuel reserves, do not allow the airplane to remain in uncoordinated flight for periods in excess of one minute.

NOTE

When the fuel selector valve handle is in the BOTH position in cruising flight, unequal fuel flow from each tank may occur if the wings are not maintained exactly level. Resulting wing heaviness can be alleviated gradually by turning the selector valve handle to the tank in the "heavy" wing.

NOTE

It is not practical to measure the time required to consume all of the fuel in one tank, and, after switching to the opposite tank, expect an equal duration from the remaining fuel. The airspace in both fuel tanks is interconnected by a vent line and, therefore, some sloshing of fuel between tanks can be expected when the tanks are nearly full and the wings are not level.

If a fuel tank quantity is completely exhausted in flight, it is recommended that the fuel selector valve be switched back to the BOTH position for the remainder of the flight. This will allow some fuel from the fuller tank to transfer back through the selector valve to the empty tank while in coordinated flight which in turn will assure optimum fuel feed during slipping or skidding flight.

The fuel system is equipped with drain valves to provide a means for the examination of fuel in the system for contamination and grade. The system should be examined before the first flight of every day and after

each refueling, by using the sampler cup provided to drain fuel from the wing tank sumps, and by utilizing the fuel strainer drain under an access panel on the left side of the engine cowling. The fuel tanks should be filled after each flight to prevent condensation.

BRAKE SYSTEM

The airplane has a single-disc, hydraulically-actuated brake on each main landing gear wheel. Each brake is connected, by a hydraulic line, to a master cylinder attached to each of the pilot's rudder pedals. The brakes are operated by applying pressure to the top of either the left (pilot's) or right (copilot's) set of rudder pedals, which are interconnected. When the airplane is parked, both main wheel brakes may be set by utilizing the parking brake which is operated by a handle below the left side of the switch and control panel. To apply the parking brake, set the brakes with the rudder pedals, pull the handle aft, and rotate it 90° down.

For maximum brake life, keep the brake system properly maintained, and minimize brake usage during taxi operations and landings.

Some of the symptoms of impending brake failure are: gradual decrease in braking action after brake application, noisy or dragging brakes, soft or spongy pedals, and excessive travel and weak braking action. If any of these symptoms appear, the brake system is in need of immediate attention. If, during taxi or landing roll, braking action decreases, let up on the pedals and then re-apply the brakes with heavy pressure. If the brakes become spongy or pedal travel increases, pumping the pedals should build braking pressure. If one brake becomes weak or fails, use the other brake sparingly while using opposite rudder, as required, to offset the good brake.

ELECTRICAL SYSTEM

The airplane is equipped with a 28-volt, direct-current electrical system (see figure 7-7). The system is powered by a belt-driven, 60-amp alternator and a 24-volt battery (a heavy duty battery is available) located in the tailcone aft of the baggage compartment wall. Power is supplied to most general electrical and all avionics circuits through the primary bus bar and the avionics bus bar, which are interconnected by an avionics power switch. The primary bus is on anytime the master switch is turned on, and is not affected by starter or external power usage. Both bus bars are on anytime the master switch and avionics power switches are turned on.

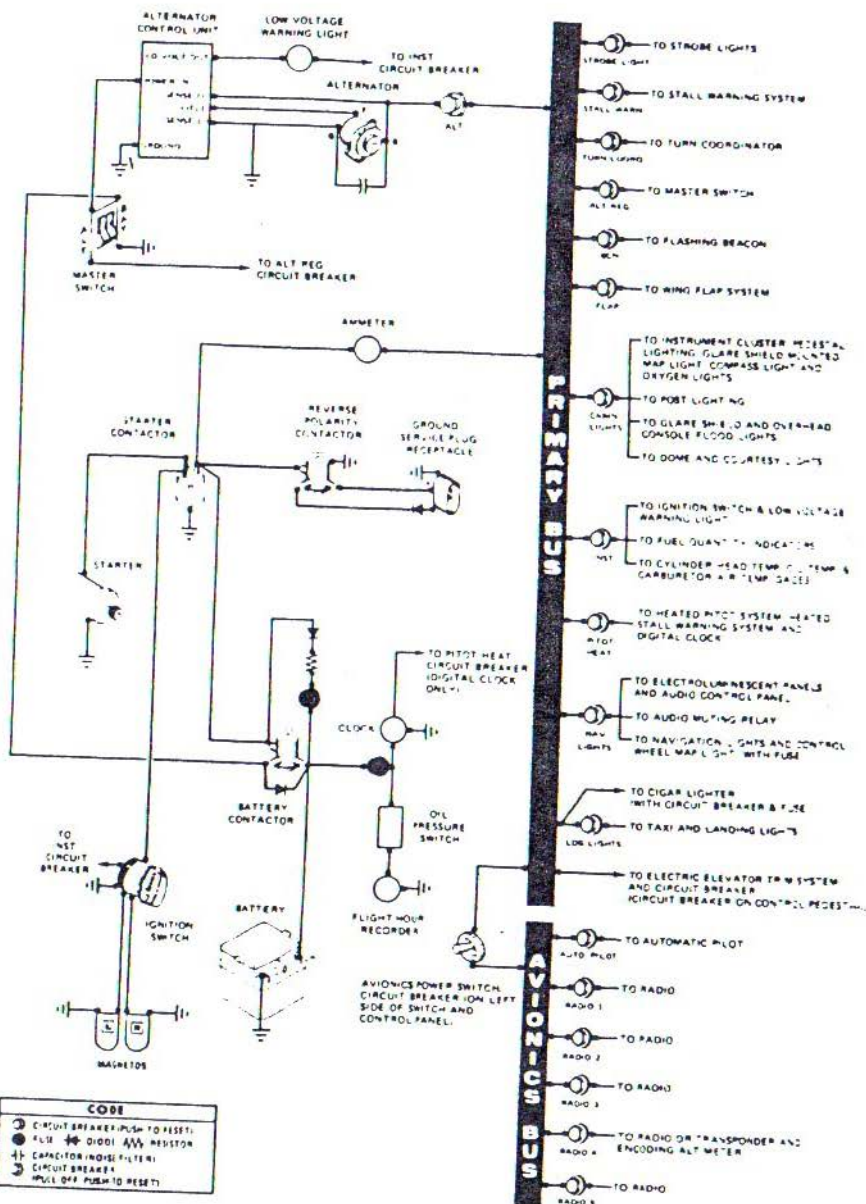

Figure 7-7. Electrical System

CAUTION

Prior to turning the master switch on or off, starting the engine, or applying an external power source, the avionics power switch, labeled AVIONICS POWER, should be turned off to prevent any harmful transient voltage from damaging the avionics equipment.

MASTER SWITCH

The master switch is a split-rocker type switch labeled MASTER, and is ON in the up position and off in the down position. The right half of the switch, labeled BAT, controls all electrical power to the airplane. The left half, labeled ALT, controls the alternator.

Normally, both sides of the master switch should be used simultaneously; however, the BAT side of the switch could be turned ON separately to check equipment while on the ground. To check or use avionics equipment or radios while on the ground, the avionics power switch must be turned ON. The ALT side of the switch, when placed in the off position, removes the alternator from the electrical system. With this switch in the off position, the entire electrical load is placed on the battery. Continued operation with the alternator switch in the off position will reduce battery power low enough to open the battery contactor, remove power from the alternator field, and prevent alternator restart.

AVIONICS POWER SWITCH

Electrical power from the airplane primary bus to the avionics bus (see figure 7-7) is controlled by a toggle switch/circuit breaker labeled AVIONICS POWER. The switch is located on the left side of the switch and control panel and is ON in the up position and off in the down position. With the switch in the off position, no electrical power will be applied to the avionics equipment, regardless of the position of the master switch or the individual equipment switches. The avionics power switch also functions as a circuit breaker. If an electrical malfunction should occur and cause the circuit breaker to open, electrical power to the avionics equipment will be interrupted and the switch will automatically move to the off position. If this occurs, allow the circuit breaker to cool approximately two minutes before placing the switch in the ON position again. If the circuit breaker opens again, do not reset it. The avionics power switch should be placed in the off position prior to turning the master switch ON or off, starting the engine, or applying an external power source, and may be utilized in place of the individual avionics equipment switches.

AMMETER

The ammeter, located between the fuel gages, indicates the amount of

current, in amperes, from the alternator to the battery or from the battery to the airplane electrical system. When the engine is operating and the master switch is turned on, the ammeter indicates the charging rate applied to the battery. In the event the alternator is not functioning or the electrical load exceeds the output of the alternator, the ammeter indicates the battery discharge rate.

ALTERNATOR CONTROL UNIT AND LOW-VOLTAGE WARNING LIGHT

The airplane is equipped with a combination alternator regulator high-low voltage control unit mounted on the engine side of the firewall and a red warning light, labeled LOW VOLTAGE, on the right side of the instrument panel adjacent to the manifold pressure gage.

In the event an over-voltage condition occurs, the alternator control unit automatically removes alternator field current which shuts down the alternator. The battery will then supply system current as shown by a discharge rate on the ammeter. Under these conditions, depending on electrical system load, the low-voltage warning light will illuminate when system voltage drops below normal. The alternator control unit may be reset by turning the master switch off and back on again. If the warning light does not illuminate, normal alternator charging has resumed; however, if the light does illuminate again, a malfunction has occurred, and the flight should be terminated as soon as practicable.

NOTE

Illumination of the low-voltage light and ammeter discharge indications may occur during low RPM conditions with an electrical load on the system, such as during a low RPM taxi. Under these conditions, the light will go out at higher RPM. The master switch need not be recycled since an over-voltage condition has not occurred to de-activate the alternator system.

The warning light may be tested by turning on the landing lights and momentarily turning off the ALT portion of the master switch while leaving the BAT portion turned on.

CIRCUIT BREAKERS AND FUSES

Most of the electrical circuits in the airplane are protected by "push-to-reset" type circuit breakers mounted on the left side of the switch and control panel. However, alternator output is protected by a "pull-off" type circuit breaker. In addition to the individual circuit breakers, a toggle switch/circuit breaker, labeled AVIONICS POWER, on the left switch and

control panel also protects the avionics systems. The cigar lighter is protected by a manually-reset type circuit breaker on the back of the lighter, and a fuse behind the instrument panel. The control wheel map light (if installed) is protected by the NAV LIGHTS circuit breaker and a fuse behind the instrument panel. Electrical circuits which are not protected by circuit breakers are the battery contactor closing (external power) circuit, clock circuit, and flight hour recorder circuit. These circuits are protected by fuses mounted adjacent to the battery.

GROUND SERVICE PLUG RECEPTACLE

A ground service plug receptacle may be installed to permit the use of an external power source for cold weather starting and during lengthy maintenance work on the electrical and electronic equipment. Details of the ground service plug receptacle are presented in Section 9, Supplements.

LIGHTING SYSTEMS

EXTERIOR LIGHTING

Conventional navigation lights are located on the wing tips and tail stinger, and dual landing/taxi lights are installed in the cowl nose cap. Additional lighting is available and includes a strobe light on each wing tip, a flashing beacon on top of the vertical stabilizer, and two courtesy lights, one under each wing, just outboard of the cabin doors. Details of the strobe light system are presented in Section 9, Supplements. The courtesy lights are operated by a switch located on the left rear door post. All exterior lights, except the courtesy lights, are operated by rocker switches on the left switch and control panel. The switches are ON in the up position and off in the down position.

The flashing beacon should not be used when flying through clouds or overcast; the flashing light reflected from water droplets or particles in the atmosphere, particularly at night, can produce vertigo and loss of orientation.

INTERIOR LIGHTING

Instrument and control panel lighting is provided by flood and integral lighting, with electroluminescent and post lighting also available. Dual concentric light dimming rheostats on the left side of the switch and control panel control the intensity of all lighting. The following paragraphs describe the various lighting systems and their controls.

The left and right sides of the switch and control panel, and the audio control panel may be lighted by electroluminescent panels which do not require light bulbs for illumination. To utilize this lighting, turn the NAV light rocker switch to the ON position and rotate the inner knob labeled EL PANEL, on the right dimming rheostat, clockwise to the desired light intensity.

Instrument panel flood lighting consists of four red lights on the underside of the glare shield, and two red flood lights in the forward section of the overhead console. This lighting is controlled by rotating the outer knob labeled FLOOD, on the left dimming rheostat, clockwise to the desired intensity.

The instrument panel may be equipped with post lights which are mounted at the edge of each instrument or control and provide direct lighting. This lighting is controlled by rotating the inner knob labeled POST, on the left dimming rheostat, clockwise to the desired light intensity. Flood and post lights may be used simultaneously by rotating both the FLOOD and POST knobs clockwise to the desired intensity for each type of lighting.

The engine instrument cluster, radio equipment, and magnetic compass have integral lighting and operate independently of post or flood lighting. To operate these lights, rotate the outer knob labeled ENG-RADIO, on the right dimming rheostat, clockwise to the desired light intensity. However, for daylight operation, the compass and engine instrument lights may be turned off while still maintaining maximum light intensity for the digital readouts in the radio equipment. This is accomplished by rotating the ENG-RADIO knob full counterclockwise. Check that the flood lights, post lights, and electroluminescent lights are turned off for daylight operation by rotating the FLOOD, POST, and EL PANEL knobs full counterclockwise.

The control pedestal has two integral lights and, if the airplane is equipped with oxygen, the overhead console is illuminated by post lights. Pedestal and console light intensity is controlled by the knob labeled ENG-RADIO, on the right dimming rheostat.

Map lighting is provided by overhead console map lights and a glare shield mounted map light. The airplane may also be equipped with a control wheel map light. The overhead console map lights operate in conjunction with instrument panel flood lighting and consist of two openings just aft of the red instrument panel flood lights. The map light openings have sliding covers controlled by small round knobs which uncover the openings when moved toward each other. The covers should be kept closed unless the map lights are required. A map light and toggle switch, mounted in front of the pilot on the underside of the glare shield, is

used for illuminating approach plates or other charts when using a control wheel mounted approach plate holder. The switch is labeled MAP LIGHT, ON, OFF and light intensity is controlled by the knob labeled FLOOD, on the left dimming rheostat. The pilot's control wheel map light (if installed) illuminates the lower portion of the cabin in front of the pilot, and is used for checking maps and other flight data during night operation. The light is utilized by turning the NAV light switch to the ON position and adjusting light intensity with the rheostat control knob on the bottom of the control wheel.

The airplane is equipped with a dome light aft of the overhead console. The light is operated by a slide-type switch, aft of the light lens, which turns the light on when moved to the right.

The most probable cause of a light failure is a burned out bulb; however, in the event any of the lighting systems fail to illuminate when turned on, check the appropriate circuit breaker. If the circuit breaker has opened (white button popped out), and there is no obvious indication of a short circuit (smoke or odor), turn off the light switch of the affected lights, reset the breaker, and turn the switch on again. If the breaker opens again, do not reset it.

CABIN HEATING, VENTILATING AND DEFROSTING SYSTEM

The temperature and volume of airflow into the cabin can be regulated by manipulation of the push-pull CABIN HEAT and CABIN AIR control knobs (see figure 7-8). Both control knobs are the double button type with locks to permit intermediate settings.

NOTE

For improved partial heating on mild days, pull out the CABIN AIR knob slightly when the CABIN HEAT knob is out. This action increases the airflow through the system, increasing efficiency, and blends cool outside air with the exhaust manifold heated air, thus eliminating the possibility of overheating the system ducting.

Front cabin heat and ventilating air is supplied by outlet holes spaced across a cabin manifold just forward of the pilot's and copilot's feet. Rear cabin heat and air is supplied by two ducts from the manifold, one extending down each side of the cabin to an outlet at the front door post at floor level. Windshield defrost air is also supplied by a duct leading from

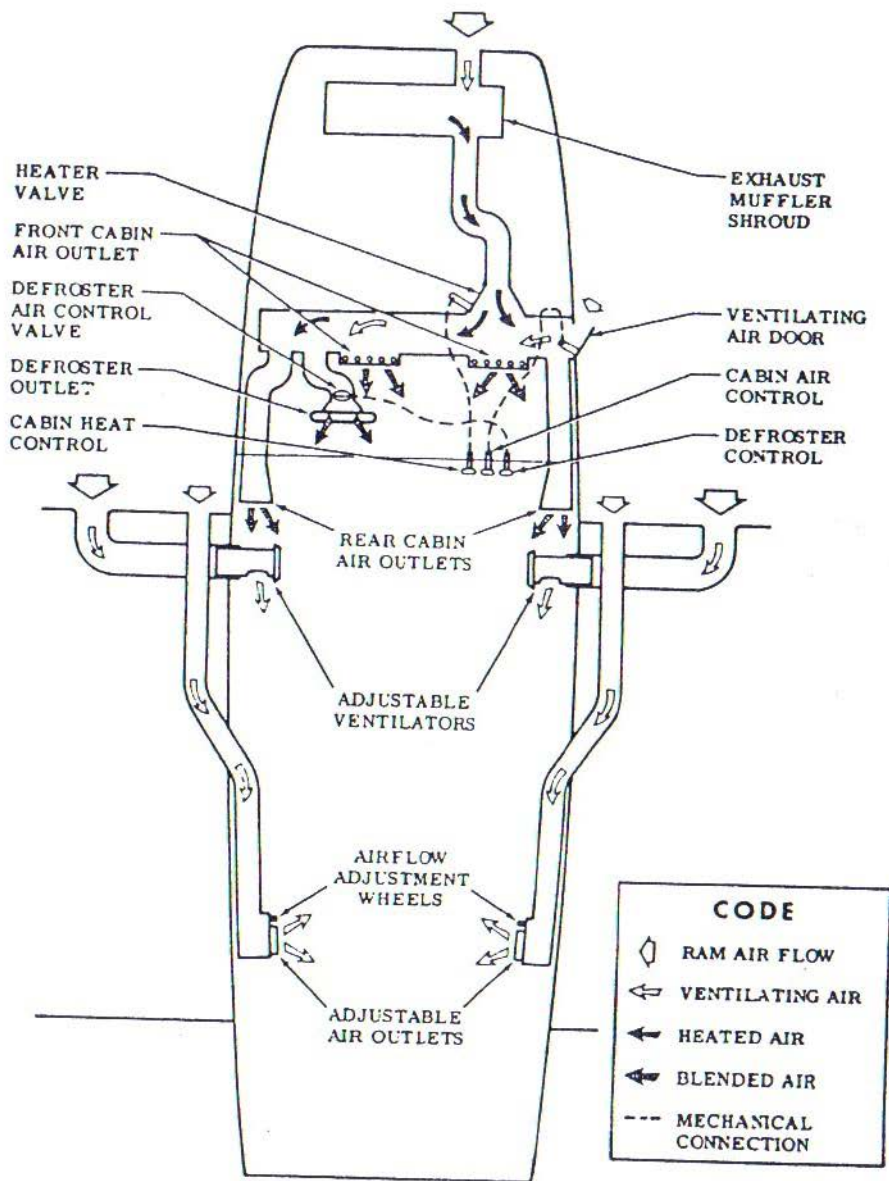

Figure 7-8. Cabin Heating, Ventilating, and Defrosting System

the cabin manifold to an outlet on top of the anti-glare shield. Defrost air flow is controlled by a rotary type knob labeled DEFROST.

For cabin ventilation, pull the CABIN AIR knob out, with the CABIN HEAT knob pushed full in. To raise the air temperature, pull the CABIN HEAT knob out until the desired temperature is attained. Additional heat is available by pulling the knob out farther; maximum heat is available with the CABIN HEAT knob pulled out and the CABIN AIR knob pushed full in.

Separate adjustable ventilators supply additional ventilation air to the cabin. One near each upper corner of the windshield supplies air for the pilot and copilot, and two ventilators are available for the rear cabin area to supply air to the rear seat passengers. Each rear ventilator outlet can be adjusted in any desired direction by moving the entire outlet to direct the airflow up or down, and by moving a tab protruding from the center of the outlet left or right to obtain left or right airflow. Ventilation airflow may be closed off completely, or partially closed according to the amount of airflow desired, by rotating an adjustment wheel adjacent to the outlet.

PITOT-STATIC SYSTEM AND INSTRUMENTS

The pitot-static system supplies ram air pressure to the airspeed indicator and static pressure to the airspeed indicator, vertical speed indicator and altimeter. The system is composed of either an unheated or heated pitot tube mounted on the lower surface of the left wing, two external static ports on the lower left and right sides of the forward fuselage, and the associated plumbing necessary to connect the instruments to the sources.

The heated pitot system (if installed) consists of a heating element in the pitot tube, a rocker switch labeled PITOT HEAT and a 10-amp push-to-reset circuit breaker on the left side of the switch and control panel, and associated wiring. When the pitot heat switch is turned on, the element in the pitot tube is heated electrically to maintain proper operation in possible icing conditions. Pitot heat should be used only as required.

A static pressure alternate source valve may be installed adjacent to the parking brake, and can be used if the external static source is malfunctioning. This valve supplies static pressure from inside the cabin instead of the external static ports.

If erroneous instrument readings are suspected due to water or ice in the pressure line going to the standard external static pressure source, be

alternate static source valve should be pulled on.

Pressures within the cabin will vary with heater/vents opened or closed, and windows open. Refer to Sections 3 and 5 for the effect of varying cabin pressures on airspeed and altimeter readings.

AIRPEED INDICATOR

The airspeed indicator is calibrated in knots and miles per hour. Limitation and range markings (in KIAS) include the white arc (45 to 95 knots), green arc (48 to 143 knots), yellow arc (143 to 179 knots), and a red line (179 knots).

If a true airspeed indicator is installed, it is equipped with a rotatable ring which works in conjunction with the airspeed indicator dial in a manner similar to the operation of a flight computer. To operate the indicator, first rotate the ring until pressure altitude is aligned with outside air temperature in degrees Fahrenheit. Pressure altitude should not be confused with indicated altitude. To obtain pressure altitude, momentarily set the barometric scale on the altimeter to 29.92 and read pressure altitude on the altimeter. Be sure to return the altimeter barometric scale to the original barometric setting after pressure altitude has been obtained. Having set the ring to correct for altitude and temperature, read the true airspeed shown on the rotatable ring by the indicator pointer. For best accuracy, the indicated airspeed should be corrected to calibrated airspeed by referring to the Airspeed Calibration chart in Section 5. Knowing the calibrated airspeed, read true airspeed on the ring opposite the calibrated airspeed.

VERTICAL SPEED INDICATOR

The vertical speed indicator depicts airplane rate of climb or descent in feet per minute. The pointer is actuated by atmospheric pressure changes resulting from changes of altitude as supplied by the static source.

ALTIMETER

Airplane altitude is depicted by a barometric type altimeter. A knob near the lower left portion of the indicator provides adjustment of the instrument's barometric scale to the current altimeter setting.

VACUUM SYSTEM AND INSTRUMENTS

An engine-driven vacuum system (see figure 7-9) provides the suction

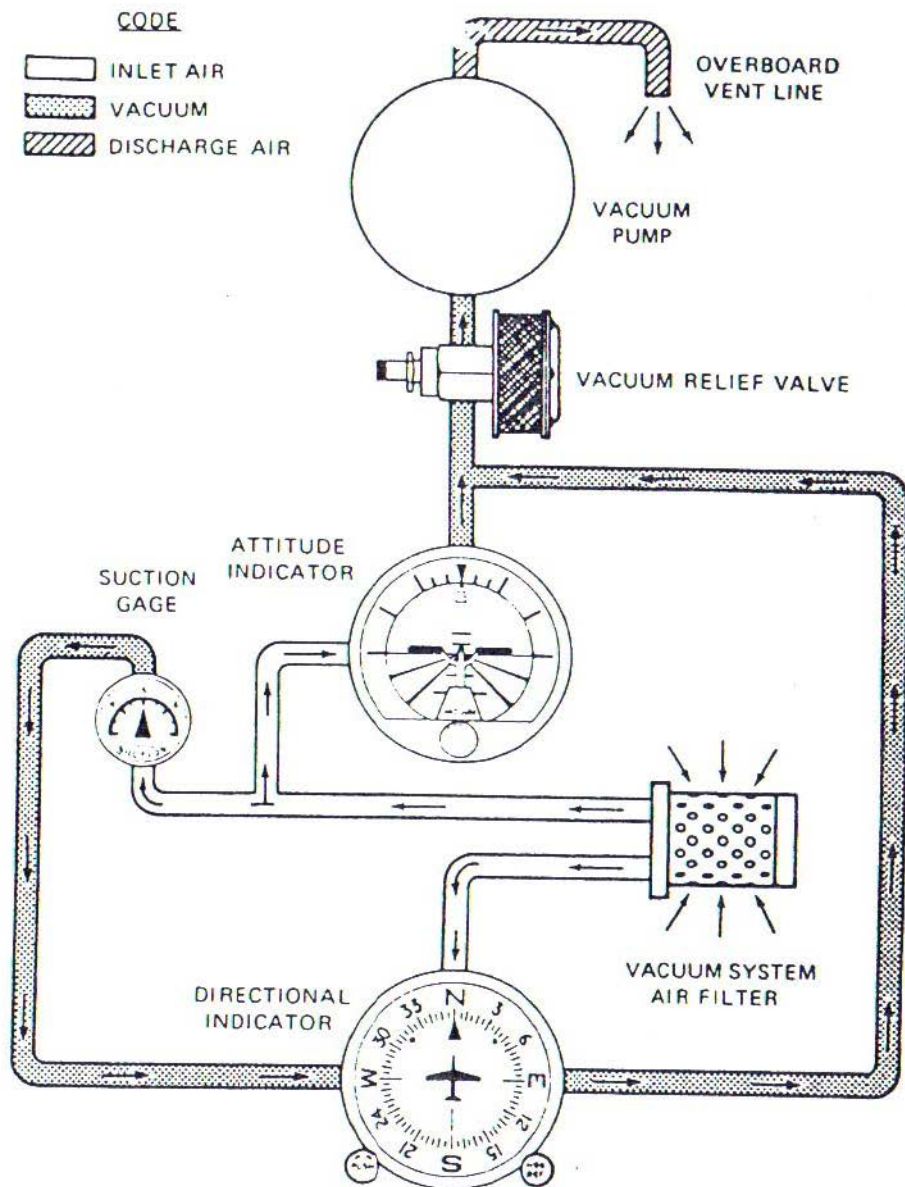

Figure 7-9. Vacuum System

necessary to operate the attitude indicator and directional indicator. The system consists of a vacuum pump mounted on the engine, a vacuum relief valve and vacuum system air filter on the aft side of the firewall below the instrument panel, and instruments (including a suction gage) on the left side of the instrument panel.

ATTITUDE INDICATOR

An attitude indicator is available and gives a visual indication of flight attitude. Bank attitude is presented by a pointer at the top of the indicator relative to the bank scale which has index marks at 10°, 20°, 30°, 60°, and 90° either side of the center mark. Pitch and roll attitudes are presented by a miniature airplane superimposed over a symbolic horizon area divided into two sections by a white horizon bar. The upper "blue sky" area and the lower "ground" area have arbitrary pitch reference lines useful for pitch attitude control. A knob at the bottom of the instrument is provided for inflight adjustment of the miniature airplane to the horizon bar for a more accurate flight attitude indication.

DIRECTIONAL INDICATOR

A directional indicator displays airplane heading on a compass card in relation to a fixed simulated airplane image and index. The directional indicator will precess slightly over a period of time. Therefore, the compass card should be set in accordance with the magnetic compass just prior to takeoff, and occasionally re-adjusted on extended flights. A knob on the lower left edge of the instrument is used to adjust the compass card to correct for any precession.

SUCTION GAGE

The suction gage, located on the left side of the instrument panel above the avionics power switch, is calibrated in inches of mercury and indicates suction available for operation of the attitude and directional indicators. The desired suction range is 4.5 to 5.4 inches of mercury. A suction reading below this range may indicate a system malfunction or improper adjustment, and in this case, the indicators should not be considered reliable.

STALL WARNING SYSTEM

The airplane is equipped with a vane-type stall warning unit, in the leading edge of the left wing, which is electrically connected to a stall warning horn under the map compartment. A 5-amp push-to-reset circuit breaker labeled STALL WARN, on the left side of the switch and control

panel, protects the stall warning system. The vane in the wing senses the change in airflow over the wing, and operates the warning horn at airspeeds between 5 and 10 knots above the stall in all configurations.

If the airplane has a heated stall warning system, the vane and sensor unit in the wing leading edge is equipped with a heating element. The heated part of the system is operated by the PITOT HEAT switch, and is protected by the PITOT HEAT circuit breaker.

The stall warning system should be checked during the pre-flight inspection by momentarily turning on the master switch and actuating the vane in the wing. The system is operational if the warning horn sounds as the vane is pushed upward.

AVIONICS SUPPORT EQUIPMENT

If the airplane is equipped with avionics, various avionics support equipment may also be installed. Equipment available includes two types of audio control panels, microphone-headset installations and control surface static dischargers. The following paragraphs discuss these items. Description and operation of radio equipment is covered in Section 9 of this handbook.

AUDIO CONTROL PANEL

Two types of audio control panels (see figure 7-10) are available for this airplane, depending upon how many transmitters are included. The operational features of both audio control panels are similar and are discussed in the following paragraphs.

TRANSMITTER SELECTOR SWITCH

When the avionics package includes a maximum of two transmitters, a two-position toggle-type switch, labeled XMTR, is provided to switch the microphone to the transmitter the pilot desires to use. If the airplane avionics package includes a third transmitter, the transmitter selector switch is a three-position rotary-type switch, labeled XMTR SEL. The numbers 1, 2, or 1, 2 and 3 adjacent to the selector switches correspond to the first, second and third (from top to bottom) transmitters in the avionics stack. To select a transmitter, place the transmitter selector switch in the position number corresponding to the desired transmitter.

The action of selecting a particular transmitter using the transmitter selector switch simultaneously selects the audio amplifier associated with that transmitter to provide speaker audio. For example, if the number one transmitter is selected, the audio amplifier in the number one NAV/COM is also selected and is used for ALL speaker audio. In the event the audio amplifier in use fails, as evidenced by loss of all speaker audio, selecting an alternate transmitter will reestablish speaker audio using the alternate transmitter audio amplifier. Headset audio is not affected by audio amplifier operation.

AUDIO SELECTOR SWITCHES

Both audio control panels (see figure 7-10) incorporate three-position toggle-type audio selector switches for individual control of the audio from systems installed in the airplane. These switches allow receiver audio to be directed to the airplane speaker or to a headset, and heard singly or in combination with other receivers. To hear a particular receiver on the airplane speaker, place that receiver's audio selector switch in the up (SPEAKER) position. To listen to a receiver over a headset, place that receiver's audio selector switch in the down (PHONE) position. The center (OFF) position turns off all audio from the associated receiver.

NOTE

Volume level is adjusted using the individual receiver volume controls on each radio.

A special feature of the audio control panel used when one or two transmitters are installed is separate control of NAV and COM audio from the NAV/COM radios. With this installation, the audio selector switches labeled NAV, 1 and 2 select audio from the navigation receivers of the NAV/COM radios only. Communication receiver audio is selected by the switches labeled COM, AUTO and BOTH. Description and operation of these switches is described in later paragraphs.

When the audio control panel for three transmitters is installed, audio from both NAV and COM frequencies is combined, and is selected by the audio selector switches labeled NAV/COM, 1, 2 and 3.

COM AUTO AUDIO SELECTOR SWITCH

The audio control panel used with either one or two transmitters incorporates a three-position toggle switch, labeled COM AUTO, which is provided to automatically match the audio of the appropriate NAV/COM communications receiver to the transmitter selected by the transmitter selector switch. When the COM AUTO selector switch is placed in the up

(SPEAKER) position, audio from the communications receiver selected by the transmitter selector switch will be heard on the airplane speaker. Switching the transmitter selector switch to the other transmitter automatically switches the other communications receiver audio to the speaker. This automatic audio switching feature may also be utilized when listening on a headset by placing the COM AUTO switch in the down (PHONE) position. If automatic audio selection is not desired, the COM AUTO selector switch should be placed in the center (OFF) position.

COM BOTH AUDIO SELECTOR SWITCH

The audio control panel used with either one or two transmitters incorporates a three-position toggle switch, labeled COM BOTH, which is provided to allow both COM receivers to be monitored at the same time. For example, if the COM AUTO switch is in the SPEAKER position, with the transmitter selector switch in the number one transmitter position, number one communications receiver audio will be heard on the airplane speaker. If it is also desired to monitor the number two communications receiver audio without changing the position of the transmitter selector switch, place the COM BOTH selector switch in the up (SPEAKER) position so that the number two communications receiver audio will be heard in addition to the number one communications receiver audio. This feature can also be used when listening on a headset by placing the COM BOTH audio selector switch in the down (PHONE) position.

NOTE

The combination of placing the COM AUTO switch in the SPEAKER position and the COM BOTH switch in the PHONE position (or vice versa) is not normally recommended as it will cause audio from both communications receivers (and any other navigation receiver with its audio selector switch in the PHONE position) to be heard on both the airplane speaker and the headset simultaneously.

AUTO AUDIO SELECTOR SWITCH

The audio control panel used with three transmitters incorporates a three-position toggle switch, labeled AUTO, which is provided to automatically match the audio of the appropriate NAV/COM receiver to the selected transmitter. To utilize this automatic feature, leave all NAV/COM audio selector switches in the center (OFF) position, and place the AUTO selector switch in either the SPEAKER or PHONE position, as desired. Once the AUTO selector switch is positioned, the pilot may then select any transmitter and its associated NAV/COM receiver audio simultaneously with the transmitter selector switch. If automatic audio selection is not desired, the AUTO selector switch should be placed in the center (OFF) position.

NOTE

If the NAV/COM audio selector switch corresponding to the selected transmitter is in the PHONE position with the AUTO selector switch in the SPEAKER position, all audio selector switches placed in the PHONE position will automatically be connected to both the airplane speaker and any headsets in use.

ANNUNCIATOR LIGHTS BRIGHTNESS AND TEST SWITCH

The audio control panel used with either one or two transmitters incorporates a three-position toggle-type switch to control the brightness level of the marker beacon indicator lights (and certain other annunciator lights associated with avionics equipment). When the switch is placed in the center (DAY) position, the indicator lights will show full bright. When this switch is placed in the up (NITE) position, the lights are set to a reduced level for typical night operations and can be further adjusted using the RADIO LT dimming rheostat knob. The down (TEST) position illuminates all lamps (except the ARC light in the NAV indicators) which are controlled by the switch to the full bright level to verify lamp operation.

SIDETONE OPERATION

Cessna radios are equipped with sidetone capability (monitoring of the operator's own voice transmission). While adjusting sidetone, be aware that if the sidetone volume level is set too high, audio feedback (squeal) may result when transmitting.

When the airplane has one or two transmitters, sidetone is provided in both the speaker and headset anytime the COM AUTO selector switch is utilized. Placing the COM AUTO selector switch in the OFF position will eliminate sidetone. Sidetone internal adjustments are available to the pilot through the front of the audio control panel (see figure 7-10). Adjustment can be made by removing the appropriate plug-button from the audio control panel (left button for headset adjustment and right button for speaker adjustment), inserting a small screwdriver into the adjustment potentiometer and rotating it clockwise to increase the sidetone volume level.

When the airplane has three transmitters, sidetone will be heard on either the speaker or a headset as selected with the AUTO selector switch. Sidetone may be eliminated by placing the AUTO selector switch in the OFF position, and utilizing the individual audio selector switches. Adjustment of speaker and headset sidetone volume can only be accomplished by adjusting the sidetone potentiometers located inside the audio control panel.

NOTE

Sidetone is not available on HF Transceivers (Types PT10-A and ASB-125), when installed.

MICROPHONE-HEADSET INSTALLATIONS

Three types of microphone-headset installations are offered. The standard system provided with avionics equipment includes a hand-held microphone and separate headset. The keying switch for this microphone is on the microphone. Two optional microphone headset installations are also available; these feature a single-unit microphone-headset combination which permits the pilot to conduct radio communications without interrupting other control operations to handle a hand-held microphone. One microphone-headset combination is offered without a padded headset, and the other version has a padded headset. The microphone-headset combinations utilize a remote keying switch located on the left grip of the pilot's control wheel. The microphone and headset jacks are located on the left side of the instrument panel. Audio to all three headsets is controlled by the individual audio selector switches and adjusted for volume level by using the selected receiver volume controls.

NOTE

When transmitting, the pilot should key the microphone, place the microphone as close as possible to the lips and speak directly into it.

STATIC DISCHARGERS

If frequent IFR flights are planned, installation of wick-type static dischargers is recommended to improve radio communications during flight through dust or various forms of precipitation (rain, snow or ice crystals). Under these conditions, the build-up and discharge of static electricity from the trailing edges of the wings, rudder, elevator, propeller tips, and radio antennas can result in loss of usable radio signals on all communications and navigation radio equipment. Usually the ADF is first to be affected and VHF communication equipment is the last to be affected.

Installation of static dischargers reduces interference from precipitation static, but it is possible to encounter severe precipitation static

conditions which might cause the loss of radio signals, even with static dischargers installed. Whenever possible, avoid known severe precipitation areas to prevent loss of dependable radio signals. If avoidance is impractical, minimize airspeed and anticipate temporary loss of radio signals while in these areas.

SECTION 8

AIRPLANE HANDLING, SERVICE & MAINTENANCE

TABLE OF CONTENTS

	Page
Introduction	8-3
Identification Plate	8-3
Owner Follow-Up System	8-3
Publications	8-3
Airplane File	8-4
Airplane Inspection Periods	8-5
FAA Required Inspections	8-5
Cessna Progressive Care	8-6
Cessna Customer Care Program	8-6
Pilot Conducted Preventive Maintenance	8-7
Alterations or Repairs	8-7
Ground Handling	8-7
Towing	8-7
Parking	8-8
Tie-Down	8-8
Jacking	8-8
Leveling	8-9
Flyable Storage	8-9
Servicing	8-10
Engine Oil	8-10
Fuel	8-11
Landing Gear	8-14
Oxygen	8-14
Cleaning and Care	8-14
Windshield-Windows	8-14
Painted Surfaces	8-15
Propeller Care	8-16
Engine Care	8-16
Interior Care	8-16

INTRODUCTION

This section contains factory-recommended procedures for proper ground handling and routine care and servicing of your Cessna. It also identifies certain inspection and maintenance requirements which must be followed if your airplane is to retain that new-plane performance and dependability. It is wise to follow a planned schedule of lubrication and preventive maintenance based on climatic and flying conditions encountered in your locality.

Keep in touch with your Cessna Dealer and take advantage of his knowledge and experience. He knows your airplane and how to maintain it. He will remind you when lubrications and oil changes are necessary, and about other seasonal and periodic services.

IDENTIFICATION PLATE

All correspondence regarding your airplane should include the SERIAL NUMBER. The Serial Number, Model Number, Production Certificate Number (PC) and Type Certificate Number (TC) can be found on the Identification Plate, located on the left forward doorpost. Located adjacent to the Identification Plate is a Finish and Trim Plate which contains a code describing the interior color scheme and exterior paint combination of the airplane. The code may be used in conjunction with an applicable Parts Catalog if finish and trim information is needed.

OWNER FOLLOW-UP SYSTEM

Your Cessna Dealer has an Owner Follow-Up System to notify you when he receives information that applies to your Cessna. In addition, if you wish, you may choose to receive similar notification, in the form of Service Letters, directly from the Cessna Customer Services Department. A subscription form is supplied in your Customer Care Program book for your use, should you choose to request this service. Your Cessna Dealer will be glad to supply you with details concerning these follow-up programs, and stands ready, through his Service Department, to supply you with fast, efficient, low-cost service.

PUBLICATIONS

Various publications and flight operation aids are furnished in the

SECTION 8
HANDLING, SERVICE
& MAINTENANCE

CESSNA
MODEL 182Q

airplane when delivered from the factory. These items are listed below.

- CUSTOMER CARE PROGRAM BOOK
- PILOT'S OPERATING HANDBOOK AND FAA APPROVED AIRPLANE FLIGHT MANUAL
- AVIONICS OPERATION GUIDE
- PILOT'S CHECKLISTS
- POWER COMPUTER
- CUSTOMER CARE DEALER DIRECTORY
- DO'S AND DON'TS ENGINE BOOKLET

The following additional publications, plus many other supplies that are applicable to your airplane, are available from your Cessna Dealer.

- INFORMATION MANUAL (Contains Pilot's Operating Handbook Information)
- SERVICE MANUALS AND PARTS CATALOGS FOR YOUR:
AIRPLANE
ENGINE AND ACCESSORIES
AVIONICS AND AUTOPILOT

Your Cessna Dealer has a Customer Care Supplies Catalog covering all available items, many of which he keeps on hand. He will be happy to place an order for any item which is not in stock.

NOTE

A Pilot's Operating Handbook and FAA Approved Airplane Flight Manual which is lost or destroyed may be replaced by contacting your Cessna Dealer or writing directly to the Customer Services Department, Cessna Aircraft Company, Wichita, Kansas. An affidavit containing the owner's name, airplane serial number and registration number must be included in replacement requests since the Pilot's Operating Handbook and FAA Approved Airplane Flight Manual is identified for specific airplanes only.

AIRPLANE FILE

There are miscellaneous data, information and licenses that are a part of the airplane file. The following is a checklist for that file. In addition, a periodic check should be made of the latest Federal Aviation Regulations to ensure that all data requirements are met.

- A. To be displayed in the airplane at all times:
1. Aircraft Airworthiness Certificate (FAA Form 8100-2).
 2. Aircraft Registration Certificate (FAA Form 8050-3).
 3. Aircraft Radio Station License, if transmitter installed (FCC Form 556).
- B. To be carried in the airplane at all times:
1. Pilot's Operating Handbook and FAA Approved Airplane Flight Manual.
 2. Weight and Balance, and associated papers (latest copy of the Repair and Alteration Form, FAA Form 337, if applicable).
 3. Equipment List.
- C. To be made available upon request:
1. Airplane Log Book.
 2. Engine Log Book.

Most of the items listed are required by the United States Federal Aviation Regulations. Since the Regulations of other nations may require other documents and data, owners of airplanes not registered in the United States should check with their own aviation officials to determine their individual requirements.

Cessna recommends that these items, plus the Pilot's Checklists, Power Computer, Customer Care Program book and Customer Care Card, be carried in the airplane at all times.

AIRPLANE INSPECTION PERIODS

FAA REQUIRED INSPECTIONS

As required by Federal Aviation Regulations, all civil aircraft of U.S. registry must undergo a complete inspection (annual) each twelve calendar months. In addition to the required ANNUAL inspection, aircraft operated commercially (for hire) must have a complete inspection every 100 hours of operation.

The FAA may require other inspections by the issuance of airworthiness directives applicable to the airplane, engine, propeller and components. It is the responsibility of the owner/operator to ensure compliance with all applicable airworthiness directives and, when the inspections are repetitive, to take appropriate steps to prevent inadvertent noncompliance.

In lieu of the 100 HOUR and ANNUAL inspection requirements, an airplane may be inspected in accordance with a progressive inspection schedule, which allows the work load to be divided into smaller operations that can be accomplished in shorter time periods.

**SECTION 8
HANDLING, SERVICE
& MAINTENANCE**

**CESSNA
MODEL 182Q**

The CESSNA PROGRESSIVE CARE PROGRAM has been developed to provide a modern progressive inspection schedule that satisfies the complete airplane inspection requirements of both the 100 HOUR and ANNUAL inspections as applicable to Cessna airplanes. The program assists the owner in his responsibility to comply with all FAA inspection requirements, while ensuring timely replacement of life-limited parts and adherence to factory-recommended inspection intervals and maintenance procedures.

CESSNA PROGRESSIVE CARE

The Cessna Progressive Care Program has been designed to help you realize maximum utilization of your airplane at a minimum cost and downtime. Under this program, your airplane is inspected and maintained in four operations at 50-hour intervals during a 200-hour period. The operations are recycled each 200 hours and are recorded in a specially provided Aircraft Inspection Log as each operation is conducted.

The Cessna Aircraft Company recommends Progressive Care for airplanes that are being flown 200 hours or more per year, and the 100-hour inspection for all other airplanes. The procedures for the Progressive Care Program and the 100-hour inspection have been carefully worked out by the factory and are followed by the Cessna Dealer Organization. The complete familiarity of Cessna Dealers with Cessna equipment and factory-approved procedures provides the highest level of service possible at lower cost to Cessna owners.

Regardless of the inspection method selected by the owner, he should keep in mind that FAR Part 43 and FAR Part 91 establishes the requirement that properly certified agencies or personnel accomplish all required FAA inspections and most of the manufacturer recommended inspections.

CESSNA CUSTOMER CARE PROGRAM

Specific benefits and provisions of the CESSNA WARRANTY plus other important benefits for you are contained in your CUSTOMER CARE PROGRAM book supplied with your airplane. You will want to thoroughly review your Customer Care Program book and keep it in your airplane at all times.

Coupons attached to the Program book entitle you to an initial inspection and either a Progressive Care Operation No. 1 or the first 100-hour inspection within the first 6 months of ownership at no charge to you. If you take delivery from your Dealer, the initial inspection will have been performed before delivery of the airplane to you. If you pick up your airplane at the factory, plan to take it to your Dealer reasonably soon after you take delivery, so the initial inspection may be performed allowing the

Dealer to make any minor adjustments which may be necessary.

You will also want to return to your Dealer either at 50 hours for your first Progressive Care Operation, or at 100 hours for your first 100-hour inspection depending on which program you choose to establish for your airplane. While these important inspections will be performed for you by any Cessna Dealer, in most cases you will prefer to have the Dealer from whom you purchased the airplane accomplish this work.

PILOT CONDUCTED PREVENTIVE MAINTENANCE

A certified pilot who owns or operates an airplane not used as an air carrier is authorized by FAR Part 43 to perform limited maintenance on his airplane. Refer to FAR Part 43 for a list of the specific maintenance operations which are allowed.

NOTE

Pilots operating airplanes of other than U.S. registry should refer to the regulations of the country of certification for information on preventive maintenance that may be performed by pilots.

A Service Manual should be obtained prior to performing any preventive maintenance to ensure that proper procedures are followed. Your Cessna Dealer should be contacted for further information or for required maintenance which must be accomplished by appropriately licensed personnel.

ALTERATIONS OR REPAIRS

It is essential that the FAA be contacted prior to any alterations on the airplane to ensure that airworthiness of the airplane is not violated. Alterations or repairs to the airplane must be accomplished by licensed personnel.

GROUND HANDLING

TOWING

The airplane is most easily and safely maneuvered by hand with the tow-bar attached to the nose wheel. When towing with a vehicle, do not exceed the nose gear turning angle of 29° either side of center, or damage to the gear will result. If the airplane is towed or pushed over a rough surface during hangaring, watch that the normal cushioning action of the nose strut does not cause excessive vertical movement of the tail and the resulting contact with low hangar doors or structure. A flat nose tire or

deflated strut will also increase tail height.

PARKING

When parking the airplane, head into the wind and set the parking brakes. Do not set the parking brakes during cold weather when accumulated moisture may freeze the brakes, or when the brakes are overheated. Close the cowl flaps, install the control wheel lock and chock the wheels. In severe weather and high wind conditions, tie the airplane down as outlined in the following paragraph.

TIE-DOWN

Proper tie-down procedure is the best precaution against damage to the parked airplane by gusty or strong winds. To tie-down the airplane securely, proceed as follows:

1. Set the parking brake and install the control wheel lock.
2. Install a surface control lock over the fin and rudder.
3. Tie sufficiently strong ropes or chains (700 pounds tensile strength) to the wing and tail tie-down fittings and secure each rope to a ramp tie-down.
4. Tie a rope (no chains or cables) to the nose gear torque link and secure to a ramp tie-down.
5. Install a pitot tube cover.

JACKING

When a requirement exists to jack the entire airplane off the ground, or when wing jack points are used in the jacking operation, refer to the Service Manual for specific procedures and equipment required.

Individual main gear may be jacked by using the jack pad which is incorporated in the main landing gear strut step assembly. When using the individual gear strut jack pad, flexibility of the gear strut will cause the main wheel to slide inboard as the wheel is raised, tilting the jack. The jack must then be lowered for a second jacking operation. Do not jack both main wheels simultaneously using the individual main gear jack pads.

If nose gear maintenance is required, the nose wheel may be raised off the ground by pressing down on a tailcone bulkhead, just forward of the horizontal stabilizer, and allowing the tail to rest on the tail tie-down ring.

NOTE

Do not apply pressure on the elevator or outboard stabilizer surfaces. When pushing on the tailcone, always apply pressure at a bulkhead to avoid buckling the skin.

To assist in raising and holding the nose wheel off the ground, weight down the tail by placing sand-bags, or suitable weights, on each side of the horizontal stabilizer, next to the fuselage. If ground anchors are available the tail should be securely tied down.

NOTE

Ensure that the nose will be held off the ground under all conditions by means of suitable stands or supports under weight supporting bulkheads near the nose of the airplane.

LEVELING

Longitudinal leveling of the airplane is accomplished by placing a level on the leveling screws located on the left side of the tailcone. Deflate the nose tire and/or lower or raise the nose strut to properly center the bubble in the level. Corresponding points on both upper door sills may be used to level the airplane laterally.

FLYABLE STORAGE

Airplanes placed in non-operational storage for a maximum of 30 days or those which receive only intermittent operational use for the first 24 hours are considered in flyable storage status. Every seventh day during these periods, the propeller should be rotated by hand through five revolutions. This action "limbers" the oil and prevents any accumulation of corrosion on engine cylinder walls.

WARNING

For maximum safety, check that the ignition switch is OFF, the throttle is closed, the mixture control is in the idle cut-off position, and the airplane is secured before rotating the propeller by hand. Do not stand within the arc of the propeller blades while turning the propeller.

After 30 days, the airplane should be flown for 30 minutes or a ground runup should be made just long enough to produce an oil temperature within the lower green arc range. Excessive ground runup should be avoided.

Engine runup also helps to eliminate excessive accumulations of water in the fuel system and other air spaces in the engine. Keep fuel tanks full to minimize condensation in the tanks. Keep the battery fully charged to prevent the electrolyte from freezing in cold weather. If the airplane is to be stored temporarily, or indefinitely, refer to the Service Manual for proper storage procedures.

SERVICING

In addition to the PREFLIGHT INSPECTION covered in Section 4, COMPLETE servicing, inspection, and test requirements for your airplane are detailed in the Service Manual. The Service Manual outlines all items which require attention at 50, 100, and 200 hour intervals plus those items which require servicing, inspection, and/or testing at special intervals.

Since Cessna Dealers conduct all service, inspection, and test procedures in accordance with applicable Service Manuals, it is recommended that you contact your Cessna Dealer concerning these requirements and begin scheduling your airplane for service at the recommended intervals.

Cessna Progressive Care ensures that these requirements are accomplished at the required intervals to comply with the 100-hour or ANNUAL inspection as previously covered.

Depending on various flight operations, your local Government Aviation Agency may require additional service, inspections, or tests. For these regulatory requirements, owners should check with local aviation officials where the airplane is being operated.

For quick and ready reference, quantities, materials, and specifications for frequently used service items are as follows:

ENGINE OIL

GRADE AND VISCOSITY FOR TEMPERATURE RANGE --

All temperatures, use SAE 20W-50 or

Above 4°C (40°F), use SAE 50.

Below 4°C (40°F), use SAE 30.

Multi-viscosity oil with a range of SAE 20W-50 is recommended for improved starting in cold weather. Ashless dispersant oil conforming to Continental Motors Specification MHS-24A (and all revisions thereto), **must be used.**

NOTE

Your Cessna was delivered from the factory with a corrosion preventive aircraft engine oil. If oil must be added during the first 25 hours, use only aviation grade straight mineral oil conforming to Specification No. MIL-L-6082.

CAPACITY OF ENGINE SUMP -- 12 Quarts.

Do not operate on less than 9 quarts. To minimize loss of oil through breather, fill to 10 quart level for normal flights of less than 3 hours. For extended flight, fill to 12 quarts. These quantities refer to oil dipstick level readings. During oil and oil filter changes, one addi-

tional quart is required when the filter is changed.

OIL AND OIL FILTER CHANGE --

After the first 25 hours of operation, drain engine oil sump and clean the oil pressure screen. If an oil filter is installed, change the filter at this time. Refill sump with straight mineral oil and use until a total of 50 hours has accumulated or oil consumption has stabilized; then change to dispersant oil. On airplanes not equipped with an oil filter, drain the engine oil sump and clean the oil pressure screen each 50 hours thereafter. On airplanes which have an oil filter, the oil change interval may be extended to 100-hour intervals, providing the oil filter is changed at 50-hour intervals. Change engine oil at least every 2 months even though less than the recommended hours have accumulated. Reduce intervals for prolonged operation in dusty areas, cold climates, or when short flights and long idle periods result in sludging conditions.

NOTE

During the first 25-hour oil and filter change, a general inspection of the overall engine compartment is required. Items which are not normally checked during a preflight inspection should be given special attention. Hoses, metal lines and fittings should be inspected for signs of oil and fuel leaks, and checked for abrasions, chafing, security, proper routing and support, and evidence of deterioration. Inspect the intake and exhaust systems for cracks, evidence of leakage, and security of attachment. Engine controls and linkages should be checked for freedom of movement through their full range, security of attachment and evidence of wear. Inspect wiring for security, chafing, burning, defective insulation, loose or broken terminals, heat deterioration, and corroded terminals. Check the alternator belt in accordance with Service Manual instructions, and retighten if necessary. A periodic check of these items during subsequent servicing operations is recommended.

FUEL

APPROVED FUEL GRADES (AND COLORS) --

100LL Grade Aviation Fuel (Blue).

100 (Formerly 100/130) Grade Aviation Fuel (Green).

NOTE

Isopropyl alcohol or ethylene glycol monomethyl ether may be added to the fuel supply in quantities not to exceed 1% or .15% by volume, respectively, of the total. Refer to

SECTION 8
HANDLING, SERVICE
& MAINTENANCE

CESSNA
MODEL 182Q

Fuel Additives in later paragraphs for additional information.

CAPACITY EACH TANK -- 46.0 U.S. Gallons.
REDUCED CAPACITY EACH TANK (WHEN FILLED TO BOTTOM OF FUEL FILLER NECK) -- 34.5 Gallons.

NOTE

To ensure maximum fuel capacity when refueling and minimize cross-feeding when parked on a sloping surface, place the fuel selector valve handle in either LEFT or RIGHT position.

NOTE

Service the fuel system after each flight, and keep fuel tanks full to minimize condensation in the tanks.

FUEL ADDITIVES --

Strict adherence to recommended preflight draining instructions as called for in Section 4 will eliminate any free water accumulations from the tank sumps. While small amounts of water may still remain in solution in the gasoline, it will normally be consumed and go unnoticed in the operation of the engine.

One exception to this can be encountered when operating under the combined effect of: (1) use of certain fuels, with (2) high humidity conditions on the ground (3) followed by flight at high altitude and low temperature. Under these unusual conditions, small amounts of water in solution can precipitate from the fuel stream and freeze in sufficient quantities to induce partial icing of the engine fuel system.

While these conditions are quite rare and will not normally pose a problem to owners and operators, they do exist in certain areas of the world and consequently must be dealt with, when encountered.

Therefore, to alleviate the possibility of fuel icing occurring under these unusual conditions, it is permissible to add isopropyl alcohol or ethylene glycol monomethyl ether (EGME) compound to the fuel supply.

The introduction of alcohol or EGME compound into the fuel provides two distinct effects: (1) it absorbs the dissolved water from the gasoline and (2) alcohol has a freezing temperature depressant effect.

Alcohol, if used, is to be blended with the fuel in a concentration of 1% by volume. Concentrations greater than 1% are not recommended since they can be detrimental to fuel tank materials.

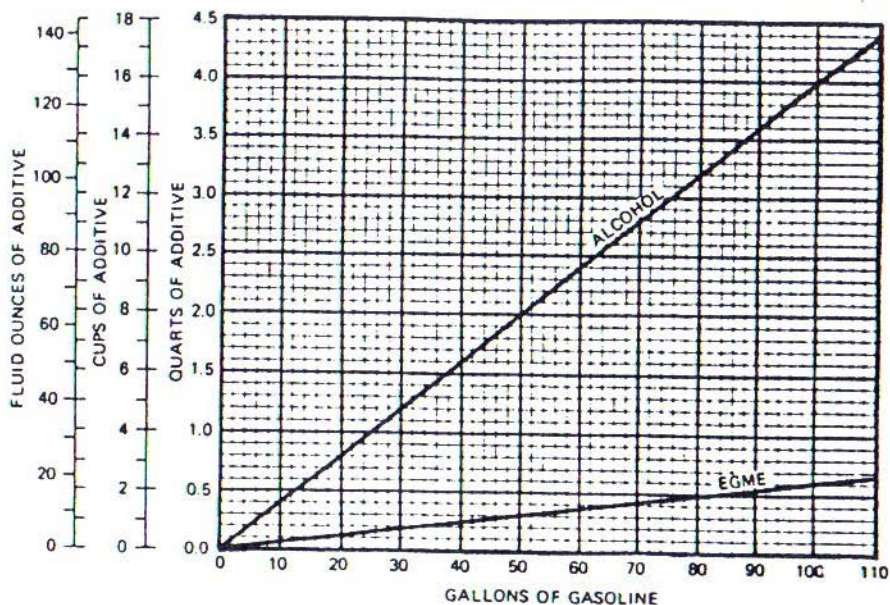

Figure 8-1. Additive Mixing Ratio

The manner in which the alcohol is added to the fuel is significant because alcohol is most effective when it is completely dissolved in the fuel. To ensure proper mixing, the following is recommended:

1. For best results, the alcohol should be added during the fueling operation by pouring the alcohol directly on the fuel stream issuing from the fueling nozzle.
2. An alternate method that may be used is to pre-mix the complete alcohol dosage with some fuel in a separate clean container (approximately 2-3 gallon capacity) and then transferring this mixture to the tank prior to the fuel operation.

Any high quality isopropyl alcohol may be used, such as Anti-Icing Fluid (MIL-F-5566) or Isopropyl Alcohol (Federal Specification TT-I-735a). Figure 8-1 provides alcohol-fuel mixing ratio information.

Ethylene glycol monomethyl ether (EGME) compound, in compliance with MIL-I-27686 or Phillips PFA-55MB, if used, must be carefully mixed with the fuel in concentrations not to exceed .15% by volume. Figure 8-1 provides EGME-fuel mixing ratio information.

CAUTION

Mixing of the EGME compound with the fuel is extremely important because a concentration in excess of that recommended (.15% by volume maximum) will result in detrimental effects to the fuel tanks, such as deterioration of protective primer and sealants and damage to O-rings and seals in the fuel system and engine components. Use only blending equipment that is recommended by the manufacturer to obtain proper proportioning.

CAUTION

Do not allow the concentrated EGME compound to come in contact with the airplane finish or fuel cell as damage can result.

Prolonged storage of the airplane will result in a water buildup in the fuel which "leeches out" the additive. An indication of this is when an excessive amount of water accumulates in the fuel tank sumps. The concentration can be checked using a differential refractometer. It is imperative that the technical manual for the differential refractometer be followed explicitly when checking the additive concentration.

LANDING GEAR

NOSE WHEEL TIRE PRESSURE -- 49 PSI on 5.00-5, 6-Ply Rated Tire.
MAIN WHEEL TIRE PRESSURE -- 42 PSI on 6.00-6, 6-Ply Rated Tires.
NOSE GEAR SHOCK STRUT --

Keep filled with MIL-H-5606 hydraulic fluid and inflated with air to 35-60 PSI. Do not over-inflate.

OXYGEN

AVIATOR'S BREATHING OXYGEN -- Spec. No. MIL-O-27210.
MAXIMUM PRESSURE (cylinder temperature stabilized after filling) -- 1800 PSI at 21°C (70°F). Refer to Oxygen Supplement (Section 9) for filling pressures.

CLEANING AND CARE

WINDSHIELD-WINDOWS

The plastic windshield and windows should be cleaned with an aircraft

windshield cleaner. Apply the cleaner sparingly with soft cloths, and rub with moderate pressure until all dirt, oil scum and bug stains are removed. Allow the cleaner to dry, then wipe it off with soft flannel cloths.

If a windshield cleaner is not available, the plastic can be cleaned with soft cloths moistened with Stoddard solvent to remove oil and grease.

NOTE

Never use gasoline, benzine, alcohol, acetone, fire extinguisher or anti-ice fluid, lacquer thinner or glass cleaner to clean the plastic. These materials will attack the plastic and may cause it to craze.

Follow by carefully washing with a mild detergent and plenty of water. Rinse thoroughly, then dry with a clean moist chamois. Do not rub the plastic with a dry cloth since this builds up an electrostatic charge which attracts dust. Waxing with a good commercial wax will finish the cleaning job. A thin, even coat of wax, polished out by hand with clean soft flannel cloths, will fill in minor scratches and help prevent further scratching.

Do not use a canvas cover on the windshield unless freezing rain or sleet is anticipated since the cover may scratch the plastic surface.

PAINTED SURFACES

The painted exterior surfaces of your new Cessna have a durable, long lasting finish and, under normal conditions, require no polishing or buffing. Approximately 10 days are required for the paint to cure completely; in most cases, the curing period will have been completed prior to delivery of the airplane. In the event that polishing or buffing is required within the curing period, it is recommended that the work be done by someone experienced in handling uncured paint. Any Cessna Dealer can accomplish this work.

Generally, the painted surfaces can be kept bright by washing with water and mild soap, followed by a rinse with water and drying with cloths or a chamois. Harsh or abrasive soaps or detergents which cause corrosion or scratches should never be used. Remove stubborn oil and grease with a cloth moistened with Stoddard solvent.

Waxing is unnecessary to keep the painted surfaces bright. However, if desired, the airplane may be waxed with a good automotive wax. A heavier coating of wax on the leading edges of the wings and tail and on the engine nose cap and propeller spinner will help reduce the abrasion encountered in these areas.

When the airplane is parked outside in cold climates and it is necessary

to remove ice before flight, care should be taken to protect the painted surfaces during ice removal with chemical liquids. Isopropyl alcohol will satisfactorily remove ice accumulations without damaging the paint. While applying the de-icing solution, keep it away from the windshield and cabin windows since the alcohol will attack the plastic and may cause it to craze.

PROPELLER CARE

Preflight inspection of propeller blades for nicks, and wiping them occasionally with an oily cloth to clean off grass and bug stains will assure long, trouble-free service. Small nicks on the propeller, particularly near the tips and on the leading edges, should be dressed out as soon as possible since these nicks produce stress concentrations, and if ignored, may result in cracks. Never use an alkaline cleaner on the blades: remove grease and dirt with Stoddard solvent.

ENGINE CARE

The engine may be cleaned with Stoddard solvent, or equivalent, then dried thoroughly.

CAUTION

Particular care should be given to electrical equipment before cleaning. Cleaning fluids should not be allowed to enter magnetos, starter, alternator and the like. Protect these components before saturating the engine with solvents. All other openings should also be covered before cleaning the engine assembly. Caustic cleaning solutions should be used cautiously and should always be properly neutralized after their use.

INTERIOR CARE

To remove dust and loose dirt from the upholstery and carpet, clean the interior regularly with a vacuum cleaner.

Blot up any spilled liquid promptly with cleansing tissue or rags. Don't pat the spot; press the blotting material firmly and hold it for several seconds. Continue blotting until no more liquid is taken up. Scrape off sticky materials with a dull knife, then spot-clean the area.

Oily spots may be cleaned with household spot removers, used sparingly. Before using any solvent, read the instructions on the container and test it on an obscure place on the fabric to be cleaned. Never saturate

the fabric with a volatile solvent; it may damage the padding and backing materials.

Soiled upholstery and carpet may be cleaned with foam-type detergent, used according to the manufacturer's instructions. To minimize wetting the fabric, keep the foam as dry as possible and remove it with a vacuum cleaner.

If your airplane is equipped with leather seating, cleaning of the seats is accomplished using a soft cloth or sponge dipped in mild soap suds. The soap suds, used sparingly, will remove traces of dirt and grease. The soap should be removed with a clean damp cloth.

The plastic trim, headliner, instrument panel and control knobs need only be wiped off with a damp cloth. Oil and grease on the control wheel and control knobs can be removed with a cloth moistened with Stoddard solvent. Volatile solvents, such as mentioned in paragraphs on care of the windshield, must never be used since they soften and craze the plastic.